



EQUIPMENT & SUPPLIES
Catalogue

LARSON·JUHL

JOINING EQUIPMENT & ACCESSORIES	
Cassese Joiners	4
Cassese Joiners, Jun-Air & Larson-Juhl Compressors & Filters	5
Compressor Accessories, Extension Table & Pneumatic Nailer	6
Flexipoints, Wedges & V-nails	7
Thumbnails, Inserts, Fillet Chopper, Sanding Disk & Cleaning Kit	8
CUTTING & MOUNTING EQUIPMENT, ACCESSORIES AND ADHESIVES	
Press & Accessories & BufferMount	9
Mounting Tissues & Release Paper	10
Adhesives	11
MAT & GLASS CUTTERS, BLADES, ACCESSORIES & DECORATION	
Mat Cutters, Wall Cutters & Accessories	12
Mat Cutting Blades/Scoring Tools & Accessories	13-14
GLUES, TAPES & CONSERVATION SUPPLIES	
Glues, 3M & Larson Juhl Tapes, & Dispenser Gun	15
ATG & Masking Tapes	16
3M Tapes, Velcro Hook and Loop & Accessories	17
Filmoplast, Hinging, Cloth, & Linen Tapes	18
Sealing, Mounting, Foam, and Framers Tapes & Gloves	19
Conservation Materials & Print Sleeves	20
HAND TOOLS, JOINING & FITTING SUPPLIES	
Vises/Brushes, Point Drivers & Brads	21
Mutimaster, Cutters, Points & Pliers	22
Stapler, Knife, Canvas Pliers, Apron & Weights	23
Fastening & Mounting Systems & Accessories	24
TOUCH-UP SUPPLIES	
Nail Hole Fillers & Touch-up Markers	25
PICTURE WIRE, SCREW EYES & HANGERS	
Art Hanging Systems & Picture Wire	26
Screw Eyes & Hangers	27
Hangers & Easel Mate	28-29
TURNBUTTONS, OFFSETS & OTHER SUPPLIES	
Turnbuttons, Offsets, Canvas Clips & Uniframe	30
Bumpons, Bumpers, Easel Backs & Mending Plates	31
Mounts, Corner Angles & Ornaments	32
Decorative Corners, Stitchery Tape, Z-Gel & EZ-Bar	33
Spacemakers & Framelights	34
BOOKS & SUPPLIES	
Framing & Books	35
PACKAGING SUPPLIES	
Kraft Paper, Dispensers, Plastic Bags, Cardboard Corners & Shrink Films	36
HARDWARE FOR METAL FRAMES	
Hardware for Metal Frames	37-38
GLAZING & MIRRORS	
Glass	39
Acrylic & Mirrors	40
Glass & Plastic Cleaners & Handling Equipment	41
PRODUCT INDEX	42-43



Cassese CS1 Cartridge Joiner

The Cassese CS 1 CART foot-operated machine combines ergonomics, ease of use, wider joining capacities and premium quality components. Designed for shops joining 10 to 20 frames per day.

- No air or electricity needed
- Can be used from the front or rear
- Accommodates wide moulding – 6" stroke
- Quick and easy wedge positioning
- Aluminum structure and parts for maximum durability & minimum wear and tear
- Solid crossbar with adjustable rod clamp and magnetic chevron clamp

ITEM #10200
Technical Data:
 Length: 24"
 Width: 14"
 Work Height: 47"
 Power: No air or electricity needed
 Max. Mldg. Width: Unlimited
 Max. Mldg. Height: 3 15/16"
 Shipping Weight: 50 lbs.

Standard Accessories:

- 1 magnetic adjustable rod clamp + 1 locking ring pin + 1 chevron holder + 1 magnetic chevron clamp + 1 chevron rubber
- Hardwood and Softwood cartridges
- 1 wedge driver blade for using Cassese Genuine Cartridge Wedges
- 2 allen keys
- 1 grease tube



Cassese CS2 Cartridge Joiner

The Cassese CS 2 CART machine utilizes the Smart Wedge Drive System, only available from Cassese, to create perfect alignment and pressure. Designed for shops joining 15 to 25 frames per day.

- Perfect Alignment eliminates the need to adjust top clamp placement
- Perfect Pressure eliminates the need to adjust air pressure between Hardwood and Softwood
- Accommodates wide moulding – 6" stroke
- Quick and easy wedge positioning
- Aluminum structure and parts for maximum durability & minimum wear and tear
- Solid crossbar with adjustable rod clamp and magnetic chevron clamp

ITEM #10201
Technical Data:
 Length: 24"
 Width: 14"
 Work Height: 47"
 Power: Air – 6 to 8 bars needed
 Max. Mldg. Width: Unlimited
 Max. Mldg. Height: 3 15/16"
 Shipping Weight: 53 lbs.

Standard Accessories:

- 1 magnetic adjustable rod clamp + 1 locking ring pin + 1 chevron holder + 1 magnetic chevron clamp + 1 chevron rubber
- Hardwood and Softwood cartridges
- 1 wedge driver blade for using Cassese Genuine Cartridge Wedges
- 2 allen keys
- 1 grease tube



Cassese CS20 Cartridge Joiner

The CS 20 CART machine is a pneumatic underpinner with powerful clamps that withstand 110 lbs. of pressure. Designed for shops joining 15 to 25 frames per day.

- Powerful double action horizontal clamp
- Self-adjusting fences
- Perfect Alignment eliminates the need to adjust top clamp placement
- Perfect Pressure eliminates the need to adjust air pressure between Hardwood and Softwood
- Accommodates wide mouldings – 6" stroke
- Quick and easy wedge positioning
- Aluminum structure and parts for maximum durability & minimum wear and tear
- Solid crossbar with adjustable rod clamp and magnetic chevron clamp

ITEM #10203
Technical Data:
 Length: 24"
 Width: 14"
 Work Height: 47"
 Power: Air – 6 to 8 bars needed
 Max. Mldg. Width: 3 15/16"
 Max. Mldg. Height: 2 15/16"
 Shipping Weight: 62 lbs.

Standard Accessories:

- 1 magnetic adjustable rod clamp + 1 locking ring pin + 1 chevron holder + 1 magnetic chevron clamp + 1 chevron rubber
- Hardwood and Softwood cartridges
- 1 wedge driver blade for using Cassese Genuine Cartridge Wedges
- 2 allen keys
- 1 grease tube



Cassese CS200 Cartridge Joiner

The CS 200 CART pneumatic underpinner (v-nailer) is for large mouldings that require a great deal of applied pressure to enhance efficiency of creating perfectly joined frames. Designed for shops joining 25 to 50 frames per day.

- Retractable and very powerful Ultra clamps
- Auto-Alignment eliminates need to adjust top clamp placement
- Self-Adjusting Pressure eliminates need to adjust air pressure between Hardwood and Softwood
- Shoot and stack up wedges
- Self-adjusting fences
- New adjustable rod clamp, magnetic chevron clamp and solid crossbar
- Aluminum structure and parts for maximum durability & minimum wear and tear

ITEM #10207

Technical Data

Length: 23"
 Width: 23 1/2"
 Work Height: 46"
 Power: Air – 6 to 8 bars needed
 Max. Mldg. Width: 5 7/8"
 Max. Mldg. Height: 3 15/16"
 Shipping Weight: 97 lbs.

Standard Accessories:

- 1 magnetic adjustable rod clamp + 1 chevron holder + 1 magnetic chevron clamp + 1 chevron rubber
- Hardwood and Softwood cartridges
- 1 wedge driver blade for using Cassese Genuine Cartridge Wedges
- 4 allen keys
- 1 grease tube
- Spacer bars
- Wedge removal tool



Jun-Air Silent Compressor

The finest silent compressor available. Ideal for shops where noise tolerance is low. Fitted with quick-connect coupler. Two-year warranty. Shipping weight: 71 lbs.

ITEM #11004

Technical Data:

Motor: .5 hp
 Displacement: 2.1 cfm
 Min. Pressure: 120 psi
 Max. Pressure: 150 psi
 Air Receiver: 6.6 U.S. gallons
 Voltage @ 60 Cycles: 110 volt +/-10%
 Power Consumption: 4.8 amps
 Noise Level: 40 dB
 Shipping Weight: 71 lbs.

Oil for Jun-Air, Half Liter

Oil is required for Jun-Air Silent Compressors.

ITEM #11010

Larson-Juhl Compressor

The Larson-Juhl Compressor is ideal for operation in small shops. 1/2 HP delivered from one motor with 2.15 CFM Free Air.

Air Pressure: Up to 120 PSI
 Tank Size: 6 gallons
 Shipping Weight: 70 lbs.

ITEM #11005

Larson-Juhl Oil

16oz container of oil to be used in the Larson-Juhl Compressor (Item #11005)

ITEM #11013

Larson-Juhl Coalescent Filter

Filters moisture from air compressor to keep air lines moisture free.

ITEM #11011

Larson-Juhl Top Intake Filter

Filters air entering the compressor to ensure pollutants do not enter the motor. 2 per kit.

ITEM #11012



Work Station Coil Hose

Lightweight coil hose can be dropped from a "T" connector over any work station. Comes fitted with quick-connect coupler and plug.

A ITEM #11612

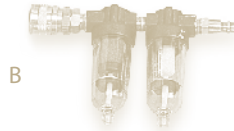

Oil and Water Filtration System

A combination air line filter system for removing moisture and oil. Reduces contaminants which can harm pneumatic tools and equipment. Especially useful to protect framing materials when using a blow gun. Comes fitted with quick-connect coupler and plug.

B ITEM #11615



Air Filter/Regulator

Recommended for installation on compressors to filter moisture from air lines and regulate air pressure to equipment. Comes fitted with quick-connect coupler and plug.

C ITEM #11617



Safety Blow Gun

Ideal for cleaning dust and particles off mats, glass, equipment and work areas. Comes fitted with quick-connect male plug.

D ITEM #11614



Circular Extension Table 299/486/399/409

Circular extension table can be used with Cassese 299, 486, 3099 and 4095.

ITEM #10022

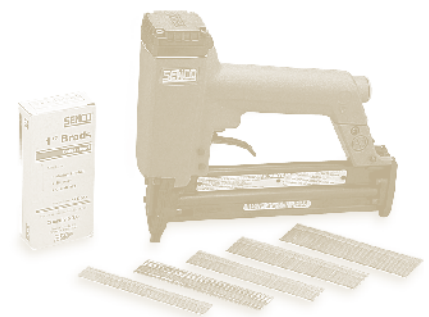

Pneumatic Brad Nailer

This pneumatic brad nailer speeds up the joining process. No pre-drilling necessary, and brads are automatically counter-sunk. Fitted for quick connection to air supply. Operates between 80 and 110 PSI (5.5 and 7.5 bars). Must be used with joining vise.

ITEM #11440



Cassese Cartridge Wedges

Cassese wedges are manufactured to precise standards to avoid jamming and are designed to drive smoothly and cleanly into the frame, pulling corners together tightly. Color-coded by size for efficient loading.

275 wedges per cartridge

Size	Cartridge Color	6 Cart./Box Item #	Bulk/40 Cart./Box Item #
5mm (3/16") softwood wedges	Orange	10401	10601
7mm (1/4") softwood wedges	Pink	10403	10602
7mm (1/4") hardwood wedges	Pink	10404	10603
10mm (3/8") hardwood wedges	Light Blue	10405	10604
10mm (3/8") softwood wedges	Light Blue	10407	10606
12mm (1/2") hardwood wedges	Dk. Blue	10411	10608
12mm (1/2") softwood wedges	Dk. Blue	10413	10610
15mm (5/8") hardwood wedges	White	10415	10612
5mm (5/8") softwood wedges	White	10417	10614

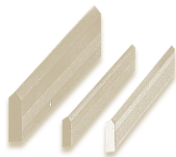

Cassese Flexipoints

Flexipoints provide great fitting security and can be bent back open for frame package retrieval many times without breaking. Used in conjunction with Cassese Flexipoint Guns.

- ITEM #11210 15mm black
15,000/box
- ITEM #11214 CS6-25 black
3,000/box

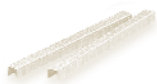

Staples for SJS Stapler

- ITEM #11413 3/8" Crown x 5/16" Leg
28,000/box
- ITEM #11415 3/8" Crown x 1/2" Leg
35,000/box

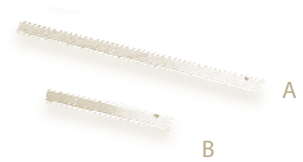

Wedge Drivers

Shaped like a V-nail, these are used to "hammer" or "drive" the Cassese wedges into wooden frames.

A ITEM #10202

Wedge Driver for CS810 and CS276. Fits CS810 and CS276 machines ONLY.

B ITEM #10204

Wedge Driver for CS79, CS88, CS89, CS299, CS386, CS486, CS830, CS910, CS3099, CS4095, C S1 CART, C S2 CART, CS 20 CART and CS 200 CART. Fits all Cassese machines EXCEPT the CS810 and the CS276 models and is approximately 2 1/2" long.



Putnam V-Nails

V-Nails for use in ITW/Amp/Putnam 11mm joiners. Patented wedges with "pulling power" pull mitred frame corners tightly together and ensure professional-looking corners.

Size	Grind	Item #	Quantity
7mm (1/4")	Hardwood	10554	4,000/box
10mm (3/8")	Softwood	10556	3,000/box
10mm (3/8")	Hardwood	10558	3,000/box
12mm (1/2")	Hardwood	10562	3,000/box
15mm (5/8")	Softwood	10564	2,000/box
15mm (5/8")	Hardwood	10566	2,000/box

Universal Wedges (V-Nails) 10.5mm wide

For joiners not using a cartridge. Superior quality, manufactured from high-carbon steel to precise tolerances. Standard 10.5mm width fits Pistorius, Euro, Arquati and most other brands. 8,000/box.

Size	Item #
7mm (1/4")*	10822
7mm (1/4")	10823
10mm (3/8")*	10824
10mm (3/8")	10825
12mm (1/2")	10827

*hardwood grind

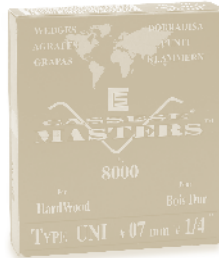

Universal "AL" Wedges 11mm wide

Manufactured from high-carbon steel to precise tolerances, the Mitre Tite Universal "AL" Wedges fit most Putnam Mitre underpinners. 8,000/box.

Size	Item #
10mm (3/8")*	10925
10mm (3/8")	10927
12mm (1/2")	10933
15mm (5/8")	10937

*hardwood grind



C&H Thumbnail Inserts

Thumbnail inserts for use with the C&H Thumbnail Joiner.

A	ITEM #11813	Small	3/8"	500/bag
B	ITEM #11815	Medium	5/8"	500/bag
C	ITEM #11817	Large	15/16"	250/bag

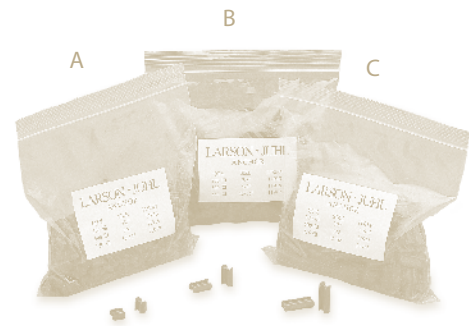

Larson-Juhl Anchor Joining System

The flexible yet rigid Larson-Juhl Anchor creates a tight corner for your frames. Works with any C&H Thumbnail router.

A	ITEM #11913	Small	3/8"	500/bag
B	ITEM #11915	Medium	5/8"	500/bag
C	ITEM #11917	Large	15/16"	250/bag

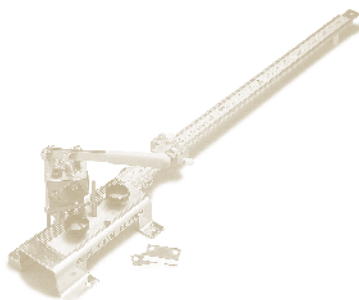

Fillet Chopper

Benchtop chopper that cuts, not crushes, wood or plastic fillets. Comes complete with measuring gauge and stops. Replacement blades available.

ITEM #12211	Trim Cutter w/Fillet Pro
ITEM #12210	Replacement Blades
ITEM #12213	24" Extension Arm



Mitre Tru Sanding Disks

Circular sanding disk replacements used on Mitre Tru Sanding machines. Durable disks provide hours of precise sanding action. 1/pkg.

ITEM # 10545



D&K Platen Cleaner Kit

A dirty press platen can damage prints, so keep the platen clean with the Bienfang Platen Cleaner Kit. 2 oz.

ITEM #14205

D&K Expressions Combination Hot/Cold VacuPress 4468H

This combination press can be used for mounting and laminating. Programmable systems controller, digital microprocessor and touch-pad controls. Use with a wide range of prints, photos and artwork for professional results. All presses are UL-listed. Accommodates oversize artwork: up to 40" x 60", 230V, single phase, electrician required. NEMA L14-20 twist-lock plug included. 495 lbs. Floor stand not included.

Interior Dimensions: 44" x 68"
Outside Dimensions: 77" x 57" x 7"

ITEM #13393

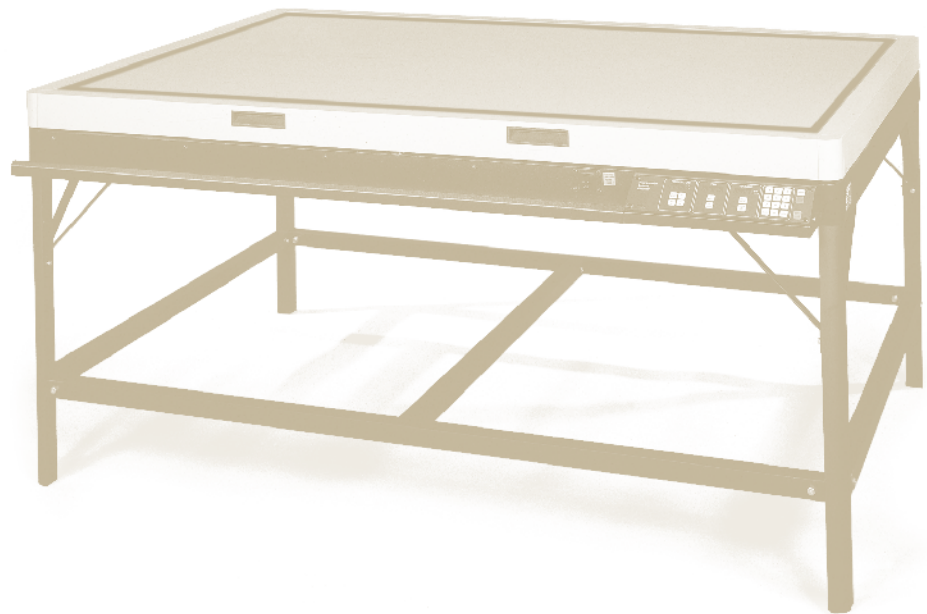

Zippy Replacement Blades 12/pk.

Blades are for use with Zippy Cutters and are 12 to a package.

ITEM #14212

BufferMount

BufferMount is a very versatile, eco-friendly and safe tissue. It is coated on both sides with a low-temperature adhesive that melts during heating, bonds as it cools and is removable when reheated. BufferMount is specially designed for mounting reproductions, photographs and posters, as well as thin, delicate materials.

ITEM #13642 24.5" x 90'

ITEM #13644 40.5" x 90'

Release Boards & Papers

Special silicone-treated paper protects press platen and artwork. Can be used repeatedly.

- ITEM #13652 32" x 40"
5/pkg.
- ITEM #13656 34" x 90"
double-sided/roll
- ITEM #13658 42" x 90"
one-sided/roll
- ITEM #13653 40" x 60"
1/pkg.

Finish Guard-UV

A transparent laminating film for protection of prints. Finish Guard is available in:

- Matte- Non-glare finish
- Canvas- Canvas texture
- ITEM #13664 Matte 41" x 50'
- ITEM #13689 Canvas 41" x 50'

ColorMount Tissue

Multi-purpose tissue for mounting both RC paper and regular photographic prints.

- ITEM #13622 24" x 150'
- ITEM #13624 40 1/2" x 150'

Fusion 4000

All-purpose removable dry-mounting adhesive. Perfect for hard-to-mount materials such as cloth, wood or metal.

- ITEM #13612 24 1/2" x 90'
- ITEM #13614 40 1/2" x 90'



RagMount

100% cotton rag tissue carrier for dry mounting digital prints or fine art paper.

- ITEM #13634 40 1/2" x 150'



TechMount Adhesive Tissues

TechMount 2 (TM2)

Porous tissue coated on both sides for a permanent, heat-activated bond. "Breathes" to permit mounting of any non-porous artwork.

- ITEM #13813 24 1/2" x 150'
- ITEM #13815 40 1/2" x 150'

Sponge Foam Overlay

Recommended for use with Finish Guard for a consistently attractive finish. Reusable, comes in a 42" x 8 1/2' roll.

- ITEM #13670



3M Photo Mount Adhesive

A strong, clear aerosol adhesive that produces high-strength bonds in seconds when pressure is applied. 10 ¼ oz. spray can.

ITEM #21203

3M Vac-U-Mount Adhesive

A strong, professional-grade vacuum press adhesive. Requires no heat for quick, easy, permanent mounting. Extended open time (up to 10 minutes) permits spraying and bonding even the largest materials. 15 oz. spray can.

ITEM #21201

3M Super "77" Adhesive

An all-purpose spray adhesive that is fast-drying, heat-and water-resistant. 16 ½ oz. spray can.

ITEM #21207

3M Spray Mount Adhesive

Excellent for mounting delicate papers. Holds firmly, yet allows lifting to smooth out wrinkles or reposition. 9 ¾ oz. spray can.

ITEM #21205

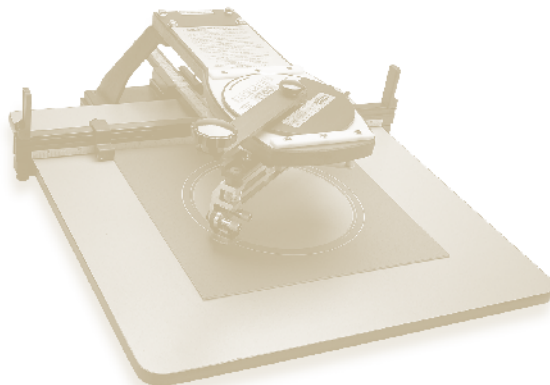

Fletcher 1100

Replacement Blades and Wheels for Fletcher 1100:

ITEM #16615	SU-01 Steel Glass Wheels	10/pkg.
ITEM #22907	Dexter #3 Blades	5/pkg.
ITEM #22216	Fletcher Carbide Glass Wheel PA3-01	1/pkg.



"Yes" Paste

A standard professional stikflat glue for wet and vacuum mounting. Transparent — will not curl or discolor if used according to directions.

ITEM #14016 gallon

SureMount Vacuum Adhesive

Acid-free and non-wetting liquid that can be thinned by water and applied by roller, brush or spray gun.

ITEM #14010 gallon



3M 568 Positionable Mounting Adhesive

Strong, permanent bond when mounting photos, artwork and preparing camera-ready paste-ups. Comes with application squeegee.

ITEM #14002 16" x 50' roll

ITEM #14004 24" x 50' roll

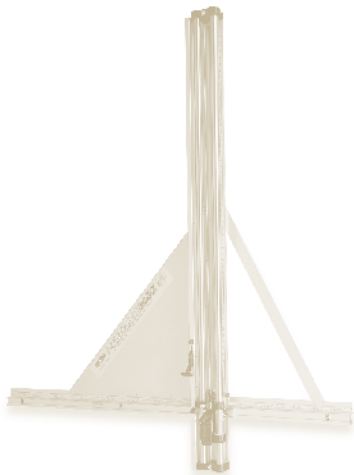

Fletcher 3000 60" Cardboard & Glass Cutter

Used for cutting and sizing mats, glass and acrylic. The Fletcher-Terry 3000 features a three-position turret-style cutting head that allows you to switch from cutting matboard to glass to acrylic with a quick turn. A full-length clamp securely holds materials when cutting. Completely adjustable for squaring. Sturdy construction of anodized aluminum. Includes 10 matcutting blades, 20 steel glass-cutting wheels, 10 acrylic cutting blades, cleaning brush, instruction manual and mounting hardware.

ITEM #16603 60", Wt. 85 lbs.

Replacement Blades & Wheels for Fletcher 3000:

ITEM #16612 M-3000 Matcutting Blades, 100/box

ITEM #16613 M-3000, 10 pkg.

ITEM #16615 SU-01 Steel Glass Cutting Wheels, 10/pkg.

ITEM #22216 PA3-01 Carbide Glass Cutting Wheel, 1/pkg.

ITEM #16202 APB-12 Acrylic Cutting Blades, 10 pkg.

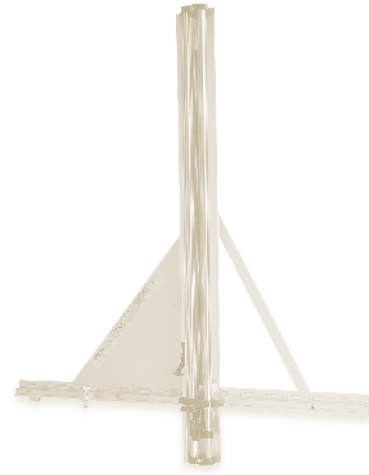

Fletcher 3100 63" Multi-Material Cutter

This versatile machine cuts through the toughest material. Used for cutting and squaring mats, glass, acrylic, gatorboard, hardboard, foamboard and mountboard. Full-length, non-slip clamp holds your materials in position without marring the surface.

ITEM #16604 Fletcher 3100 63" Multi-Material Cutter, Wt. 90 lbs.

Replacement Blades & Wheels for Fletcher 3100:

ITEM #16620 Fletcher 3100 Mat blades, 100/box

ITEM #16615 SU-01 Steel Glass Cutting Wheels, 10/pkg.

ITEM #22216 PA3-01 Carbide Glass Cutting Wheel, 1/pkg.

ITEM #16202 APB-12 Acrylic Cutting Blades, 10/pkg.

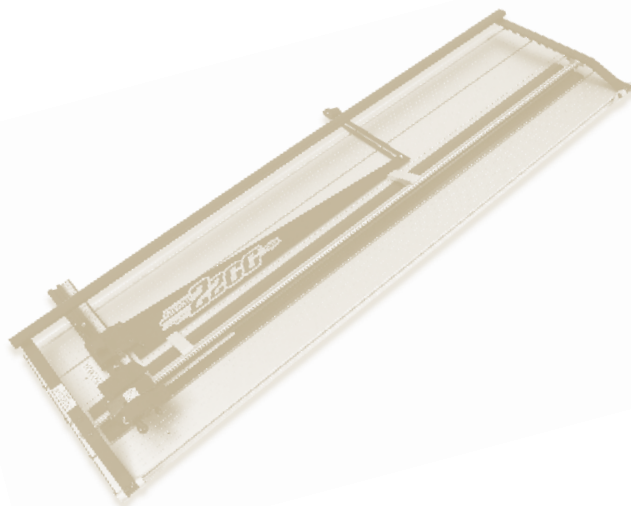

Fletcher 2200 Professional Mat Cutting System

Offers superior mat-cutting features: The cutting head is designed to fit your hand and glides on friction-free bearings. The unique blade magazine makes changing blades quicker and safer, and the new longer mat guide improves top-to-bottom accuracy on larger mats. Durable anodized aluminum construction. Each cutter comes with 1 box of Fletcher "Super Keen" mat cutting blades.

ITEM #15009 48" Shipping wt: 45 lbs.

ITEM #15010 60" Shipping wt: 50 lbs.

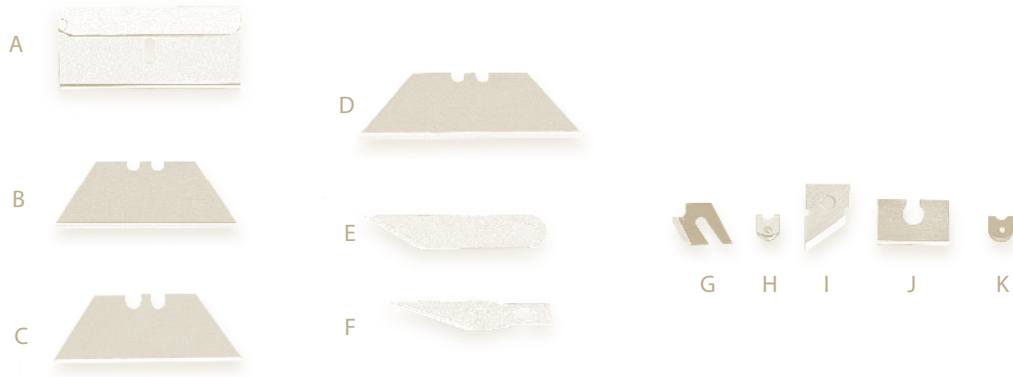

Blades for use with Cardboard, Glass and Acrylic Cutters

No. 12 Notched Blades

Wraparound sleeve on one edge of the blade. For use on Keeton and C&H Super deluxe-style matcutters. Individually wrapped for protection.

A ITEM #15836 100/box

#991 Utility Blades

Regular utility blades for use in any Larson-Juhl, C&H and Carithers straight blade holder. Also used in cardboard and glass cutters, and retractable utility knife.

B ITEM #15840 100/box

Fletcher 3100 Mat Blades

For use with the Fletcher 3100 Multi-Material Wall cutter (Item #16604) and the Fletcher 2200 Mat Cutters (Item #15009 and #15010).

C ITEM #16620 100/box

#992 Heavy-Duty Utility Blades

Heavy-duty utility blade used with C&H G60, BG6000/6100 Wall cutters and the retractable utility knife. Longer and thicker than #991 utility blades.

D ITEM #15842 100/box

Dexter #3 Blades for Paper Back Trimming Knife

For use in Paper Back Trimming Knife and Fletcher 1100.

E ITEM #22907 5/pkg.

X-Acto #11 Blades

For use with the X-Acto Gripster Knife.

F ITEM #22928 15/pkg.

APB-12 Plastic Blades

Used to cut acrylic and plastic.

G ITEM #16202 10/pkg.

Fletcher SU-01 Steel Glass Wheels

Used to score glass in the Fletcher Wall Cutters, Fletcher Oval Cutters, C&H G-60 Advantage wall cutter.

H ITEM #16615 10/pkg.

Fletcher M-81 Blades

Fletcher blades used only on the Fletcher 8400.

I ITEM #16617 10/pkg.

M-3000 Blades for Fletcher 3000

For use ONLY in Fletcher 3000 Mat, Glass and Acrylic cutter.

J ITEM #16613 10/pkg.

ITEM #16612 100/box

Fletcher PA3-01 Carbide Glass Wheel

Carbide glass wheels are used to score glass and designed for extended wear. For use in Fletcher, C&H glass cutters.

K ITEM #22216 1/pkg.



Wizard CMC Blades

Replacement blades for the Wizard 8000/8500, and 5000 series CMC machines.

- A** ITEM #16701 45° Blades for 8000/8500 CMC 500/box
- B** ITEM #16703 45° Blades for 5000/Eclipse CMC 500/box



Single-Edge Mat Cutter Blades

C&H

- ITEM #15816 #1200SE 100/box
- ITEM #15817 #1500SE 100/box

Fletcher

- ITEM #15825 #1500SE 100/box Super Keen

#1200 and #1500 Mat Cutter Blades

Larson-Juhl

- ITEM #15802 #1200 100/box
- ITEM #15804 #1500 100/box

C&H

- ITEM #15812 #1200 100/box
- ITEM #15814 #1500 100/box

Fletcher

- ITEM #15822 #1200 100/box Super Keen
- ITEM #15824 #1500 100/box Super Keen

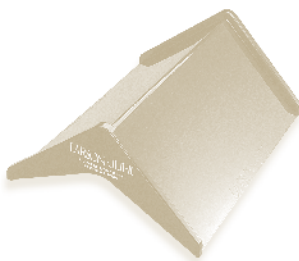

Artique Matboard Rack

An attractive black matboard rack designed to hold Artique Conservation Matboard samples.

ITEM #LJR



Larger Kneaded Eraser

Soft, pliable eraser kneads into any shape to remove marks cleanly. Individually wrapped.

ITEM #20419



Corner Weld Super Glue

Water-soluble wood glue that dries clear. Available in Black and White. A standard in the industry developed by FramERICA.

- ITEM #21002 2 pints (White)
- ITEM #21004 gallon (White)
- ITEM #21006 2 pints (Black and White)
- ITEM #21008 gallon (Black)
- ITEM #21009 2 pints (Black)

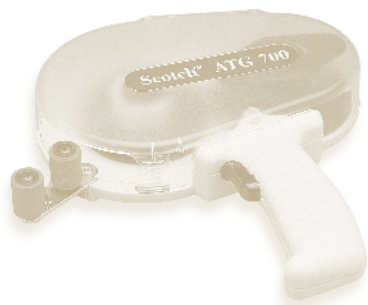

Scotch 700 ATG Dispenser Gun by 3M

Dispensing gun for ATG tape up to 60 yards, which saves time on reloading.

ITEM #21460



Scotch 889 Conservation Tape by 3M

Permanent, acid-free, double-sided tape for mounting, matting and more.

ITEM #21479 3/4" x 36 yds.



Scotch 924 Adhesive Transfer Tape by 3M

Ideal for adhering double mats and applying paper dust cover to back of picture frames. An instant bonding tape that is sticky on both sides. Fits in ATG #700 gun (Item #21460).

- ITEM #21404 3/4" x 36 yds.
- ITEM #21402 1/2" x 36 yds.
- ITEM #21401 1/4" x 36 yds.
- ITEM #21406 1/2" x 11 yds.
- ITEM #21468 3/4" x 60 yds.
- ITEM #21466 1/2" x 60 yds.



A B

Larson-Juhl ATG Tape

General purpose adhesive tape for mounting, laminating, and holding framing materials. Backed by Larson-Juhl quality standards, this double sided tape will meet a variety of framing needs. Box or case only.

- A ITEM #21518 1/2" x 36 yds.
- B ITEM #21520 1/2" x 60 yds.



Scotch ATG Gold Tape by 3M

Acid-free ATG tape is available in three sizes. Available in 36 or 60 yards.

- ITEM #21462 1/2" x 36 yds.
- ITEM #21463 1/2" x 60 yds.
- ITEM #21464 1/4" x 36 yds.



Scotch 969 Adhesive Transfer Tape by 3M

With more aggressive holding power than 924 ATG, this is an excellent choice for heavy or wide mats, fabrics or needlework and rough surfaces.

- ITEM #21405 1/2" x 18 yds.
- ITEM #21480 3/4" x 36 yds.



Scotch 465 ATG Tape by 3M

This double-sided adhesive transfer tape fits on normal- to large-core tape dispensers. Large core.

- ITEM #21411 1/4" x 60 yds.
- ITEM #21412 3/8" x 60 yds.



D990 ATG Tape

This ATG tape comes on a mylar carrier and will fit the 3M #700 dispenser (Item #21460).

- ITEM # 21661 1/2" x 72 yds.



3M #2600 Masking Tape

Made of natural-colored crepe paper, this tape is used in wrapping and packaging of completed projects. This tape is highly acidic and should not be used inside the framing package.

- ITEM #21418 3/4" x 60 yds.



Fillet Tape D670

A high-bond ATG designed especially for fillets.

- ITEM #21662 1/4" x 36 yds.



Scotch 234 Masking Tape by 3M

A low-tack, removable tape used in wrapping and packaging of completed projects. Made of natural-colored crepe paper, this tape is highly acidic and should not be used inside the framing package. Large core.

- ITEM #21419 1" x 60 yds.



3M 987 Highland ATG Tape

A lower tack and economical alternative to 924 tape. For use on smaller mats or applications where less bonding strength is needed. Fits ATG #700 gun (Item #21460).

- A** ITEM #21454 3/4" x 36 yds.
- B** ITEM #21452 1/2" x 36 yds.
- ITEM #21453 1/2" x 60 yds.

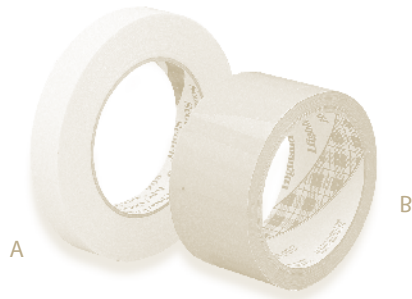

Scotch 896 Filament Tape by 3M

A glass filament tape used for closing, reinforcing or bundling applications. Super strong. Large core.

A ITEM #21420 3/4" x 60 yds.

Highland 3710 Box Sealing Tape by 3M

A strong film tape for box sealing and packaging. Split and burst resistant; seals out dirt and dust. Large core.

B ITEM #21422 2" x 60 yds.



Scotch 810 Magic Transparent Tape by 3M

Versatile, dependable 810 Magic Transparent Tape has hundreds of uses. Thin, strong and invisible on most surfaces. Can be written on with ink, pencil or marker. Large core.

ITEM #21416 3/4" x 72 yds.

Scotch 811 Magic Plus Transparent Tape by 3M

This removable, transparent tape is nearly invisible and can be written on with ink, pencil or marker. Good for screening mat borders when applying decorative powders. Large core.

ITEM #21414 3/4" x 72 yds.



ScotchMark 256 Artist's Tape by 3M

Treated white paper tape, perfect for adding decorative touches like covered bevel edges to mats. Large core.

ITEM #21443 3/4" x 60 yds.

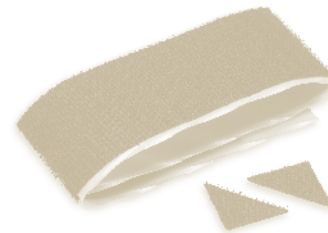

Velcro Hook Triangles for Corner Samples

1" x 1" triangles used to hang corner samples. 50 triangles/bag.

ITEM #21508

ATG Pick-Up Stick

Finally, a way to clean off all those unwanted strips of ATG tape without damaging matboard. Just erase and dispose of tape.

ITEM #21413

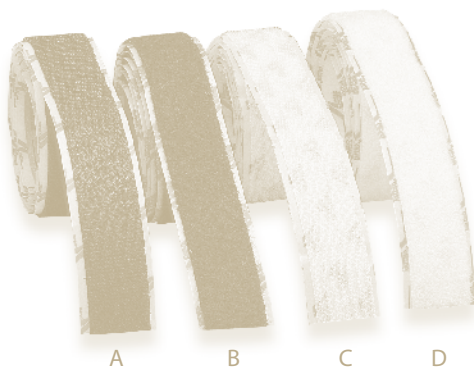
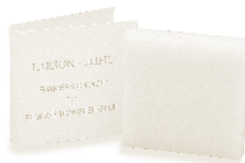

Velcro Hook and Loop Tape

Great for hanging corner samples and other applications where reusable fastening is required. Super-stick backing. Can be ordered by the yard or full 25-yard rolls.

- A** ITEM #21504 1" Black Hook Tape
- B** ITEM #21506 1" Black Loop Tape
- C** ITEM #21503 1" White Hook Tape
- D** ITEM #21502 1" White Loop Tape



Filmoplast P90 Tape

Acid-free, will not harden or penetrate surface; age-resistant and neutral. Self-adhesive paper has high holding power, which can be reinforced on heavy pieces by wider, additional hinges. Not recommended for conservation hinging of artwork.

ITEM #21601 3/4" x 165'

Filmoplast SH Tape

Acid-free, high-quality cloth shirting tape for hinging heavy pieces of art or sandwiching the mat and backing of higher-end framing jobs. Not recommended for conservation hinging of artwork.

ITEM #21603 1 3/16" x 82'



Self-Adhesive Linen Cloth Tape

Acid-free acrylic pressure sensitive adhesive for hinging matboards together. Not intended for direct contact with high-quality artwork.

ITEM #21657 1 1/4" x 35'



Abaca SA Hinging Tape

Self-adhesive hinging tape is acid-free and biodegradable.

ITEM #21665 7/8" x 150'



Acid-Free Linen Tape

Acid-free cloth linen tape with water-activated adhesive to attach mounting board to top matboard.

ITEM #21607 1" x 50 yds.

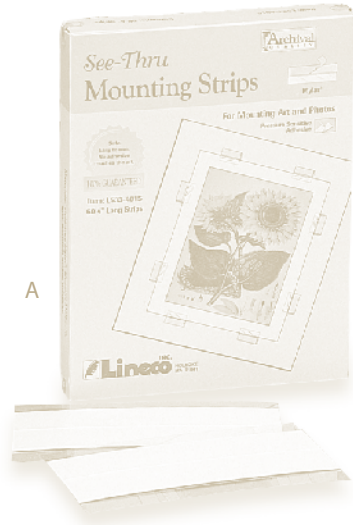

A

Lineco "See Thru" Mylar Mounting Strips

A safe, hingeless way of mounting artwork. DuPont Archival Mylar attaches to acid-free paper with an instant self-adhesive backer. Packaged in 4" lengths. Can be easily cut to smaller sizes.

A ITEM #21619 60/box



B

Lineco Frame Sealing Tape

Use on finished or unfinished wood surfaces, pH-neutral adhesive, no need for messy shellacs. Very aggressive adhesive — not for use directly on artwork.

B ITEM #21649 1 1/4" x 1,000" (27.5 yds.)

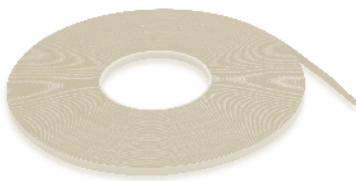

Lineco Rabbet Foam Tape

Self-adhesive tape protects canvas transfers, digital art and other media from sticking to wood rabbets.

ITEM #21612 1/4" x 36 yds.



Pure Rice Starch Adhesive

Dry rice starch is used for traditional museum mounting and hinging and requires water and heat to make an adhesive paste.

ITEM #21659



Framer's Tape II

White hinging tape with acid- and solvent-free adhesive. Nonporous film backing remains stable. No adhesive bleed-through and no harmful plasticizers. Not recommended for hinging to conservation-quality artwork.

ITEM #21608 3/4" x 180'

ITEM #21609 1" x 180'



Cotton Gloves

Used to handle any valuable or delicate artwork, including textiles, to prevent oils in the skin from being transferred to and left upon the surface. One size fits all.

ITEM #27001 12/pkg.



Mulberry Paper Strips

Made of 100% imported Japanese Sekishu and designed for use with pure rice starch adhesive (Item #21659). Strips are feather-edged and hand-torn.

ITEM #21617 5 strips/pkg. 1 1/2" x 24"

Larson-Juhl Conservation Corner Mounts

Clear, acid-free polyethylene corners; permanent, yet allow for easy mounting and removal of valued art pieces. Triangular shape affords maximum visibility in minimal-border areas. Available in 4 sizes.

ITEM #21712	1 ¼" Full Corner	250/box
ITEM #21716	2 15/16" Full Corner	100/box
ITEM #21718	2 15/16" Maxi-Vision	100/box
ITEM #21714	1 ¼" Maxi-Vision	250/box

Print Sleeves

High-quality heavy-duty print sleeves are double-stitched for durability and security with a pH-neutral board insert. Available in size 30" x 40". Sold individually.

ITEM #21700



Document Cleaning Pad

Pad contains a soft, grit-free powder that absorbs and cleans surface dirt on paper items.

ITEM #21653



Burnishing Bone

Ideal for burnishing mat decorating strips to make the design permanent. Easy-to-hold shape reduces fatigue.

ITEM #22919

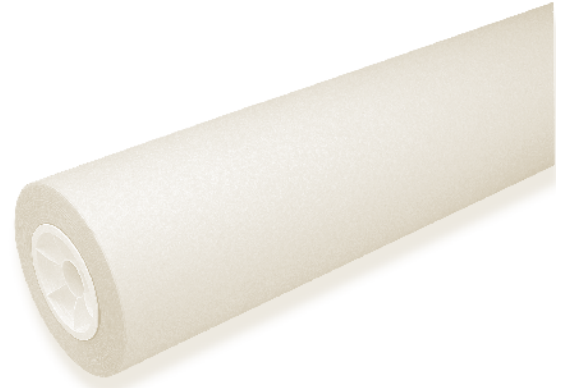

Lineco Framebacker Paper

Archival-grade Framebacker Paper is acid- and lignin-free, buffered, easy to cut, fold and handle. Strong enough to resist punctures and tearing. Light gray. 40 lb.

ITEM #21658 36" x 300'



Larson-Juhl Backing Paper, Grey

Larson-Juhl Conservation Backing Paper available in 36" x 500' rolls.

- Acid-Free
- Lignin-Free
- Alkaline pH Buffered

ITEM #21670 36" x 500'

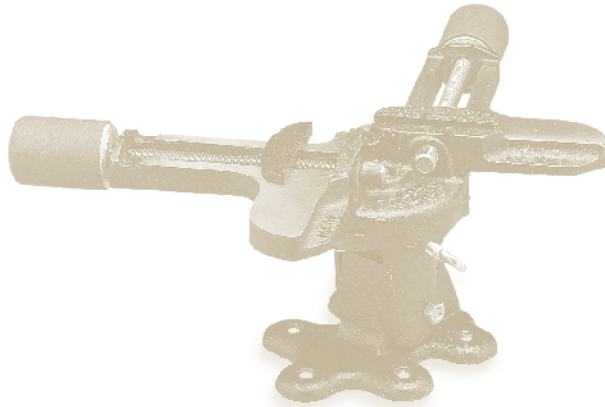

Larson-Juhl Joining Vise

The Larson-Juhl vise is made of durable cast-iron construction with knurled speed handles for easy clearance when drilling and nailing small moulding. Clamps mouldings up to 4" wide. Comes complete with tilt base.

ITEM #22002



Dusting Brush

14" professional draftsman's brush. Soft, 100% horse hair is ideal for dusting off mats, frames and art work.

A ITEM #22917

Static Wisk Framer's Brush

Made from a blend of natural goat hair and a synthetic dissipative fiber, Static Wisk zaps static and gently brushes away dust from glass, plexi, plastic, mats, photos, prints and artwork. 5 1/2" wide.

B ITEM #22939

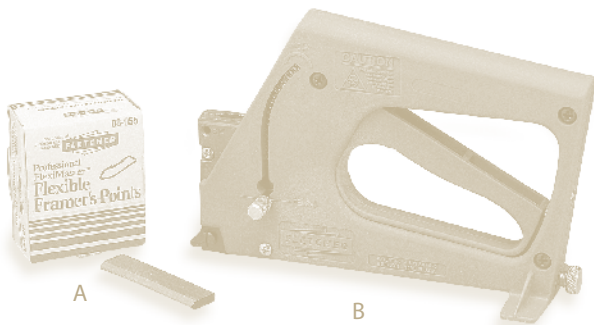

Fletcher FlexiMaster Driver

Adapted from Fletcher's FrameMaster point driver, this light-weight hand-operated gun fires Fletcher black Flexible Framer's Points. Perfect for shops without an air compressor.

A ITEM #22209 Flexible Framer's Points 3,700/box

B ITEM #22203 FlexiMaster Driver (green gun)

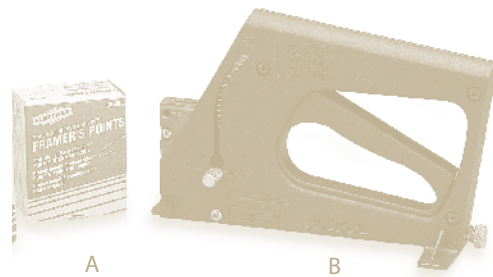

Fletcher FrameMaster Point Driver

This lightweight, manual driver is designed specifically for the framing trade. Quickly install points to fit snugly in all types of wood. FrameMaster driver can use Framer's Points for most frames or use shorter Glazier's Points for small frames, very hard woods and shadow boxes.

A ITEM #22205 Framer's Points 3,000/box

B ITEM #22201 FrameMaster Point Driver (black gun)



F18 Brads

These 1 1/16" brads fit the Salco F-18 Brad Gun. Manufactured in Italy to the highest standards.

ITEM #22412 1 1/16" Brads 5,000/box



Fletcher MultiMaster

This lightweight, hand-operated gun fires the flexible MultiMaster points. The specially designed twin-barbed multipoints are ideal for stacking frames together.

ITEM #22231 Flexible Multipoints



Awl

High-quality awl with hardened steel shank and hardwood handle.

ITEM #22810

Fletcher Score Master 1 Glass Cutter Replacement Head

Replacement Head for Fletcher Score Master 1 Glass Cutter. Carbide glass wheel in the narrow cutting head for general-purpose cutting.

ITEM #22223 Replacement Head



Fletcher No. CA2 Carbide Glass Cutter

Hand-held and disposable carbide glass cutter with a cast-iron handle. Gold tipped with silver band which indicates Carbide Cutter.

ITEM #22215



Fletcher FrameMaster Points

Points come in a box of 12,000 and fit the Fletcher FrameMaster Pneumatic Point Driver and the manual FrameMaster Gun.

ITEM #22234



Fletcher No. 2 Glass Cutter

Hand-held and disposable, steel glass cutter with a cast-iron handle.

ITEM #22213



Fletcher Glass Nipping & Running Pliers

The versatile Fletcher nipping and running pliers comes with one set of nipping jaws.

ITEM #22217 8"



Fletcher Double Edged Plastic Cutter

Used to cut acrylic and other types of plastic. Great for framers who do not have a plastic scoring wall cutter. Hand-held.

ITEM #22214

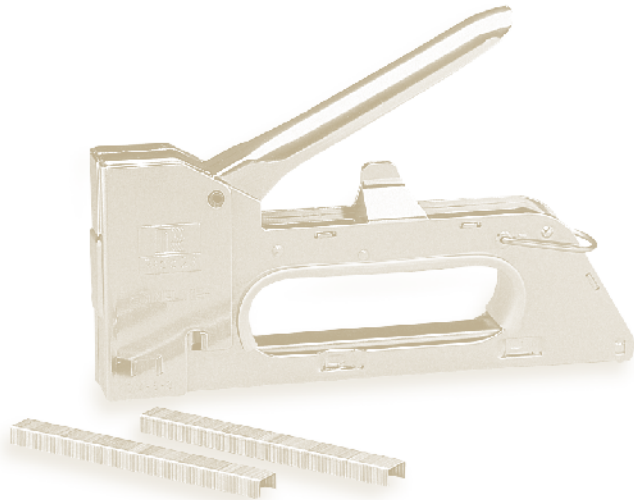

Canvas Stapler

Heavy-duty fabric stapler designed specifically for canvas stapling and other fabrics. Easy-access staple channel can handle up to 8mm staples.

ITEM #22914

Canvas Staples

High-quality fabric staples specifically designed for canvas and other fabrics. 8mm staples intended for canvas stapler Item # 22914.

ITEM #22916



Canvas Stretching Pliers

Excellent tool for stretching fabric and canvas. Made of heavy duty chromium plated steel with a no-slip, spring return handle.

ITEM #22913



X-Acto Gripster Knife

Soft, rubberized handle for comfort and control of knife. Blade included.

A ITEM #22924 Knife

B ITEM #22928 #11 Replacement Blades 15/pkg.

10 ft. Tape Measure

This 1/2" x 10' ruler with powerlock has an easy-to-read yellow nylon-coated blade.

ITEM #22812



Dexter #3 Replacement Trimming Blades

ITEM #22907 5/pkg.



Larson-Juhl Print Weights

Soft, subtle, leather print weights with no hard edges to damage artwork. Use to flatten artwork while designing.

ITEM #26406 4 print weights/pkg.

Larson-Juhl Framer's Apron

Stay clean and organized with a Larson-Juhl framer's apron. Made from a durable poly-cotton twill, the apron has three reinforced pockets. Medium length, 20" x 24".

ITEM #22931





EZ-Tach

The EZ-Tach mounting system provides a fast and efficient method for mounting most three-dimensional objects to matboard and foamboard. Easily attaches items such as books, pens, jewelry and medals.

ITEM #22437 is a complete kit and includes:

- 7.9" Polyester string fasteners 50/pkg.
- 4.7" Polyester string fasteners 50/pkg.
- 9" Polypropylene fasteners 50/pkg.
- 5" Polypropylene fasteners 50/pkg.
- 3" Polypropylene fasteners 50/pkg.
- Washer spools
- Detailed instruction book



Replacement Items for Fletcher Attach-EZ

1/64" Microtach T-End Fasteners

1/64" T-End Fasteners are used with the Red Microtach Fastening Gun.

A ITEM #22433

1/4" Fine Fabric T-End Fasteners

1/4" T-End Fasteners are used with the Pink Microtach Fastening Gun for fine fabric.

B ITEM #22435

1/2" Fine Fabric T-End Fasteners

1/2" T-End Fasteners are used with the Pink Microtach Fastening Gun for fine fabric.

C ITEM #22431



Attach-EZ Starter Kit

The Attach-EZ Starter Kit is designed to increase the speed, accuracy and convenience of framing garments and other fabric-based items, such as dolls, ribbons, silk flowers, needlework and more. The complete kit contains both Microtach Fastening Guns, Pink for smaller, delicate objects and Green, for general mounting, plus 1/4" T-End Fasteners (1,600), 1/2" T-End Fasteners (1,600), 2 needles, MicroTech fasteners and an owner's manual.

ITEM #22426



Replacement Needles for Attach-EZ

Replacement needles are used with the Pink Microtach Fastening Gun for fine fabric.

ITEM #22427 2/pkg.

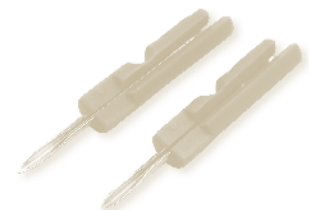

Replacement Needles-Microtach for Attach-EZ

Replacement needles are used with the Grey Microtach Fastening Gun.

ITEM #22429 2/pkg.



Regular Nail Hole Fillers

Wood-toned putties can be intermixed to obtain any shade. For best results, warm tins for easy mixing. Do not heat over direct flame or heating element. 2 oz. tins.

- ITEM #23212 Gold
- ITEM #23213 Dark Gold
- ITEM #23214 Silver
- ITEM #23215 Black
- ITEM #23216 White
- ITEM #23217 Blond Maple
- ITEM #23218 Dark Provincial Maple
- ITEM #23220 Dark Walnut
- ITEM #23221 Light Oak
- ITEM #23222 Mahogany
- ITEM #23223 Medium Maple
- ITEM #23224 Natural
- ITEM #23225 Walnut
- ITEM #23236 Red
- ITEM #23237 Yellow
- ITEM #23238 Blue
- ITEM #23239 Green

Larson-Juhl Custom Colors

- ITEM #23226 Imperial Silver
- ITEM #23227 Dark Mahogany
- ITEM #23228 Williamsburg
- ITEM #23229 Gold n' Silver
- ITEM #23230 Pecan
- ITEM #23231 Birch
- ITEM #23232 New Walnut
- ITEM #23233 Wheat

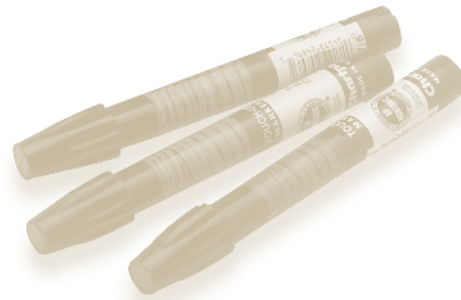

Touch-up Markers

Easy-to-use touch-up markers are angled on one side and are used for covering minor scratches and corner touch-ups.

- | | |
|-------------------------------------|----------------------------|
| ITEM #23700 Basic Gray | ITEM #23714 Prussian Blue |
| ITEM #23701 Black | ITEM #23715 True Blue |
| ITEM #23702 Light Oak | ITEM #23716 Ice Blue |
| ITEM #23703 Medium Oak | ITEM #23717 Maroon |
| ITEM #23704 Dark Oak | ITEM #23718 Wine Red |
| ITEM #23705 Red Mahogany | ITEM #23719 Salmon |
| ITEM #23706 Light Pine | ITEM #23720 Evergreen |
| ITEM #23707 Medium Cherry | ITEM #23721 Leaf Green |
| ITEM #23708 Dark Cherry | ITEM #23722 Grass Green |
| ITEM #23709 Walnut/Mahogany | ITEM #23723 Cadmium Yellow |
| ITEM #23710 Dark Walnut | |
| ITEM #23711 Blender (to Mix Colors) | |
| ITEM #23712 Crimson | |
| ITEM #23713 Ultra Marine | |



Rub 'n Buff

Wax metallic finishing product can be used to touch up scratched or slightly damaged frames. Easy application. 1/2" fl. oz. tubes.

- ITEM #23240 Antique Gold
- ITEM #23242 Gold Leaf



Pilot Touch-up Markers

Easy-to-use gold and silver markers for frame touch-up.

- ITEM #23630 Gold
- ITEM #23632 Silver

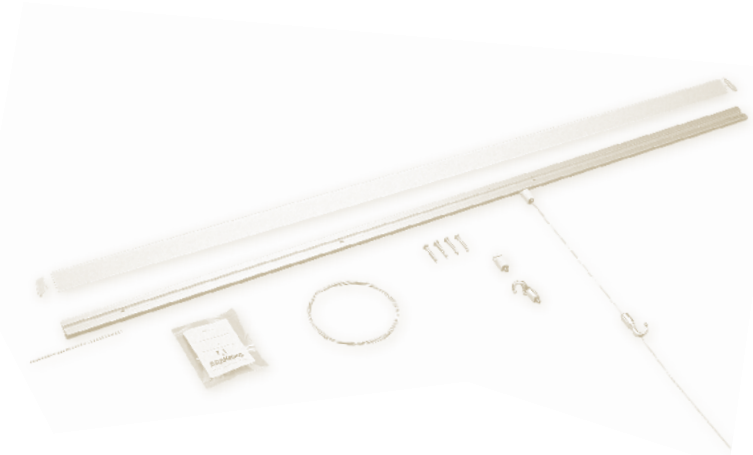

Arakawa Hanging System

Used in museums and art galleries worldwide as an easy-to-use and cost-efficient method for presenting hanging artwork in an attractive and professional manner. Arakawa Hanging System components are 6' rails (all rail packages include screws, rail cover, end caps and line up rod), rail clip, midway hook, 5' and 7' stainless-steel cables soldered at both ends.

- ITEM #11504 Rail Clip
- ITEM #11506 5' Cable
- ITEM #11505 Midway Hook
- ITEM #11507 7' Cable
- ITEM #11503 6' Rail

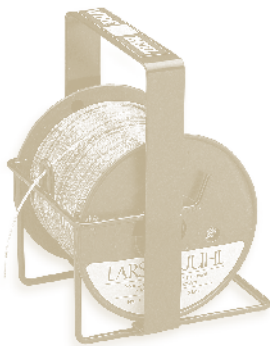

Picture Wire Caddy

Holds any 5-lb. spool of wire regardless of gauge. Has convenient carrying handle. Designed for easy spool replacement.

ITEM #23802

Plastic Coated Wire

A clean, plastic-coated wire that ends pricked fingers and wall marks. Strong yet flexible, it is easy to tie and requires no crimping tool or sleeves.

- ITEM #23832 #2 for 15 lbs. 1,350'/spool
- ITEM #23833 #3 for 20 lbs. 1,000'/spool
- ITEM #23834 #4 for 25 lbs. 750'/spool
- ITEM #23836 Super #6 for 40 lbs. 575'/spool

Larson-Juhl Picture Wire

The finest braided wire available in 4 sizes, 5-lb. spools.

- ITEM #23812 #2 for 15 lbs. 1,350'/spool
- ITEM #23813 #3 for 20 lbs. 1,000'/spool
- ITEM #23814 #4 for 25 lbs. 750'/spool
- ITEM #23816 #6 for 40 lbs. 575'/spool



Super Soft Strand Wire

Vinyl-coated, stranded stainless steel wrapping wire. Corrosion resistant, easy to wrap and knot.

- ITEM #23853 #3 for 20 lbs 1125'
- ITEM #23854 #4 for 25 lbs 850'
- ITEM #23856 #5 for 43 lbs 500'
- ITEM #23858 #6 for 60 lbs 275'
- ITEM #23860 #8 for 100 lbs 125'



Surflon Wiring System

The Surflon system is fast, neat, durable and stylish — a professional look. Braided stainless-steel wire, nylon-coated with crimping sleeves in black.

- ITEM #23822 40 lbs., 1000'/spool
- ITEM #23824 Sleeves for 23822, 1,000/bag
- ITEM #23826 60 lbs., 1,000'/spool
- ITEM #23828 Sleeves for 23828, 1,000/bag

Screws

Available in both flat-head and pan-head styles, these screws will come in handy when you need them most. All styles, 100/bag.

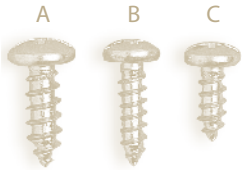

Actual Size

Pan-Head Screws

Size	ITEM #
A 8 x 1/2"	#24060
B 6 x 1/2"	#24058
C 6 x 3/8"	#24056

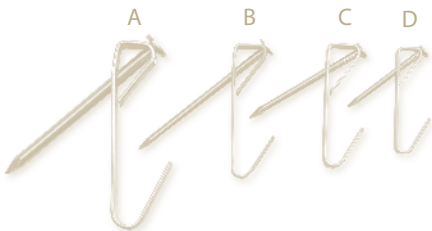

Courtesy Hangers

One hanger and nail per bag. Available in 10, 20, 30 and 50 lb, 100 or 1,000 per box.

A	ITEM #24429	50 lb.	100/box
B	ITEM #24506	30 lb.	100/box
C	ITEM #24504	20 lb.	100/box
D	ITEM #24502	10 lb.	100/box

Bulk Courtesy Hangers

ITEM #24518	50 lb.	1,000/box
ITEM #24516	30 lb.	1,000/box
ITEM #24514	20 lb.	1,000/box
ITEM #24512	10 lb.	1,000/box

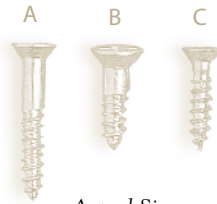

Actual Size

Flat-Head Screws

Size	ITEM #
A 4 x 3/4"	#24052
B 6 x 1/2"	#24054
C 4 x 1/2"	#24050



Actual Size

Screw Eyes (Short Shank)

Contains 200 zinc-plated screw eyes. 200/pkg.

ITEM #24000 211 3/8"

Bulk Screw Eyes (Short Shank)

All bulk packages contain 1,000/box.

ITEM #24010	211	3/8" (largest)
ITEM #24002	212	3/8"
ITEM #24004	213	3/8"
ITEM #24006	214	5/16"



Larson-Juhl Premium Picture Hangers

Brass-plated hooks, tempered-steel nails with solid-brass heads leave barely a trace of a nail hole when removed.

ITEM #24304	20 lb.	100 hooks and nails/bag
ITEM #24306	30 lb.	100 hooks and nails/bag
ITEM #24308	50 lb.	100 hooks and nails/bag
ITEM #24309	75 lb.	100 hooks and nails/bag



Bulk Nail-Less Sawtooth Hangers

Easy installation without the fuss of nails.

ITEM #24035	2"	1,000/box
ITEM #24029	7/8"	1,000/box

Bulk Sawtooth Hangers

ITEM #24033	2 7/8"	1,000/box
ITEM #24031	1 7/8"	1,000/box

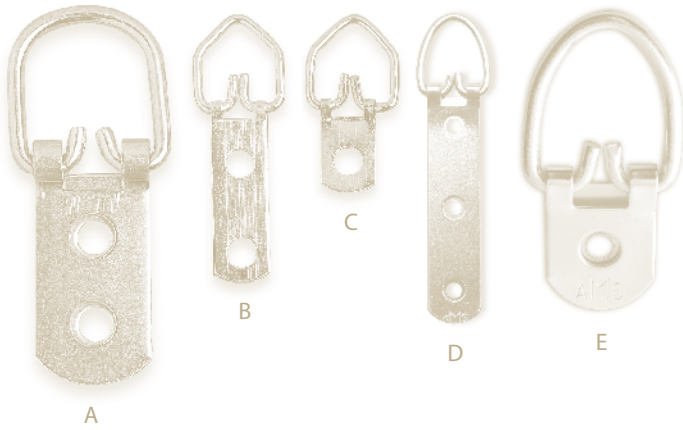

Strap Hangers

Durable hangers for better holding power on large pictures. Zinc-plated, 100/bag with screws included.

- A** ITEM #24025 2-Hole Mirror hanger
- B** ITEM #24023 Double-screw strap hanger
- C** ITEM #24021 Single-screw strap hanger
- D** ITEM #24026 3-Hole Heavy Duty 50/pkg.
- E** ITEM #24027 Single-Screw Heavy Duty 100/pkg.



"Super Steel" Hangers

Excellent substitute for screw eyes in soft-wood and FramERICA mouldings. Two sizes available. Each box contains hangers and screws for 100 frames.

- A** ITEM #24013 Super Steel II 3 1/2" (for large pictures)
- B** ITEM #24011 Super Steel I 2" (for small pictures)



Zig-Zag Hangers

Lightweight hanger with pressure-sensitive adhesive used for hanging foamboard-mounted artwork.

ITEM #24037 100/bag



"Kwik" Foamboard Hangers

Inserts easily into foamboards for hanging posters, maps, etc.

ITEM #24036 100/bag

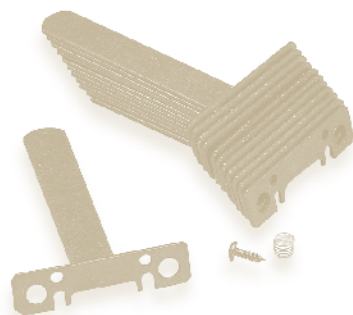

Albin Easel Mate

Turn metal and wood frames into customized tabletop photo frames! L-shaped hinge fits securely into a metal frame to form an easel base.

ITEM #24519 12/pkg.

WallBuddies Picture Hangers

WallBuddies allow you to hang pictures level and prevent the pictures from moving. WallBuddies are available for wood or metal frames.



WallBuddies for Use with Metal Frames

ITEM #24014 For Metal Frames 11" x 14" and up
Bulk Packed, 25 sets/pkg.

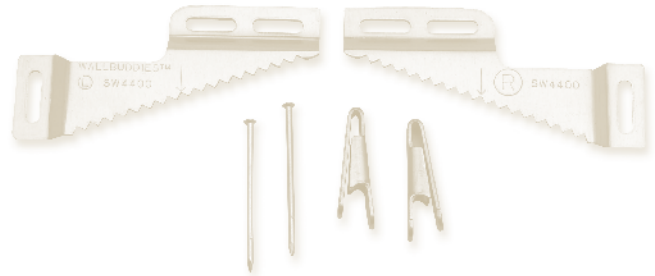

WallBuddies for Use with Wood Frames

Screws not included.

ITEM #24015 For Wood Frames up to 26" x 34"
Bulk Packed, 25 sets/pkg.

ITEM #24016 For Wood Frames 26" x 34" and up
Bulk Packed, 25 sets/pkg.

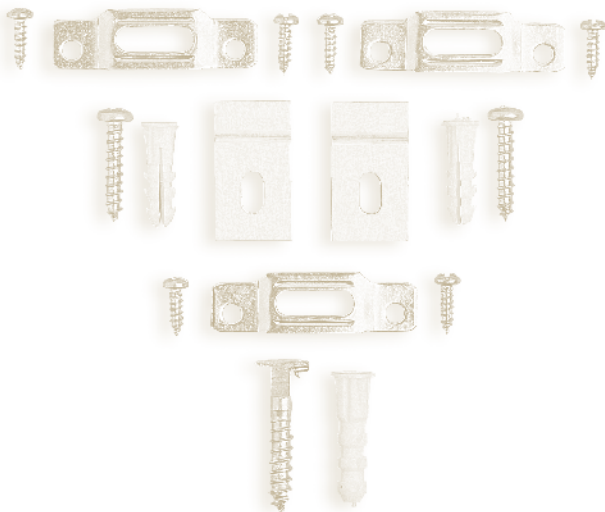

Wood Security Hangers

Tamper-proof hangers for wood moulding where security is desired. Comes in single polybags or in bulk for 100 frames. Requires the use of #24051 wrench for installation and removal.

ITEM #24045 Polybag, 1/pkg.

ITEM #24047 For 100 frames, includes wrench (Bulk)

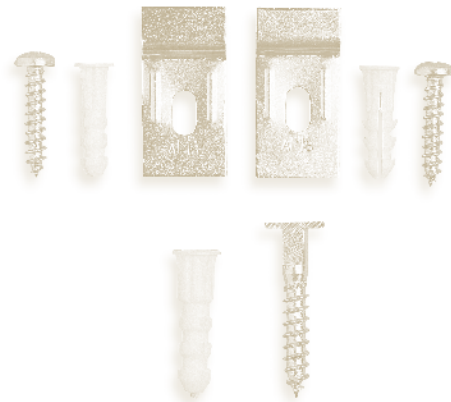

Metal Security Hangers

Fits most common metal moulding profiles. Simple installation for hanging in areas where security is desired. Comes in single polybags or in bulk for 100 frames. Requires the use of Item #24051 wrench for installation and removal.

ITEM #24041 Polybag, 1/pkg.

ITEM #24043 For 100 frames, includes wrench (Bulk)



Wrench for Security Hanger

Wrench used to lock and unlock frame from wall.

ITEM #24051

Offset Clips

Used to secure stretchers to a frame, these clips have a variety of other handy uses, including stacking frames. 100/bag with screws included.

- A ITEM #24817 1/2"
- B ITEM #24815 3/8"
- C ITEM #24813 1/4"
- D ITEM #24811 1/8"

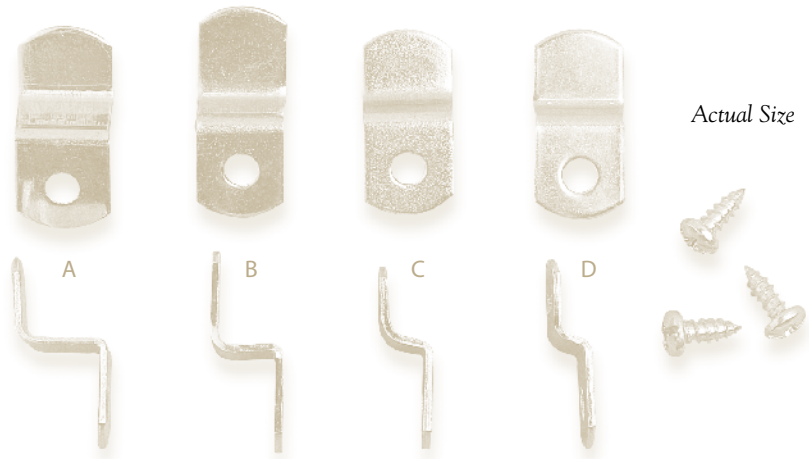

Single Canvas Offset Clips

- A ITEM #24809 3/4" 100/pkg.
- B ITEM #24808 1" 100/pkg.

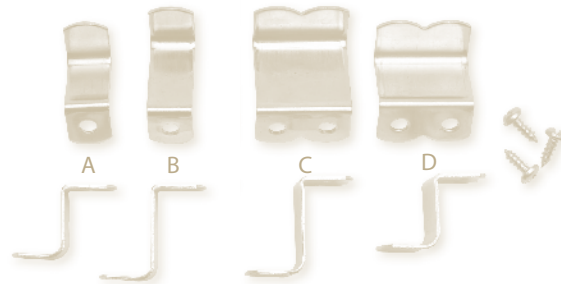

Double Canvas Offset Clips

- C ITEM #24805 1" 50/pkg.
- D ITEM #24806 3/4" 50/pkg.

Turnbuttons

Quality brass-plated turnbuttons for "quick change" setting of pictures. Screws included. 100 per bag.

- ITEM #24801 Large Turnbuttons 1"
- ITEM #24803 Small Turnbuttons 11/16"



Canvas Clips

Reliable and easy-to-use canvas clips are safely attached to the back of moulding and extend over to rest securely on back of stretcher stock. No screwing or clipping directly into canvas. Two sizes available. (Screws not included.)



- ITEM #24825 2" x 1/4" 200/box
- ITEM #24826 3" x 3/8" 200/box



Uni-Frame 20

Uni-Frame 20 is designed for prints with top or side dimensions that range from 10" to 20". Made from a tough flexible plastic. Available individually or in counter-display cartons of 12.

ITEM #25631

Uni-Frame 40

Uni-Frame 40 is designed for prints with top or side dimensions that range from 20" to 40". Available individually, in counter-display cartons of 12 or cases of 72.

ITEM #25633

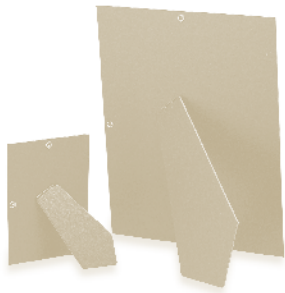

Easel Backs

These easel backs come in four sizes and can be trimmed to fit most frames. Made of durable chip board faced with black paper.

- ITEM #25402 4" x 5" w/ 5/8" drop
- ITEM #25404 5" x 7" w/ 5/8" drop
- ITEM #25406 8" x 10" w/ 5/8" drop
- ITEM #25408 11" x 14" w/ 5/8" drop

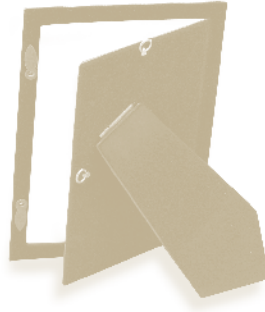

Flocked-Door Easel Back

These attractive flocked-door easel backs are covered with a velvet-type backing and can stand horizontally or vertically.

- ITEM #25411 4 1/2" x 6" w/ 3 1/2" x 5" opening
- ITEM #25413 5" x 7" w/ 4" x 6" opening
- ITEM #25417 6" x 8" w/ 5" x 7" opening
- ITEM #25419 9" x 11" w/ 8" x 10" opening



Larson-Juhl Bumpers

Bumpers will protect your walls and keep frames straight. Strong self-adhesive backing and resilient rubber at a great value. Extra large bumpers are ideal for large frames.

- A** ITEM #25215 Extra Large Bumpers 1000/box
- B** ITEM #25219 Clear Bumpers 1000/box

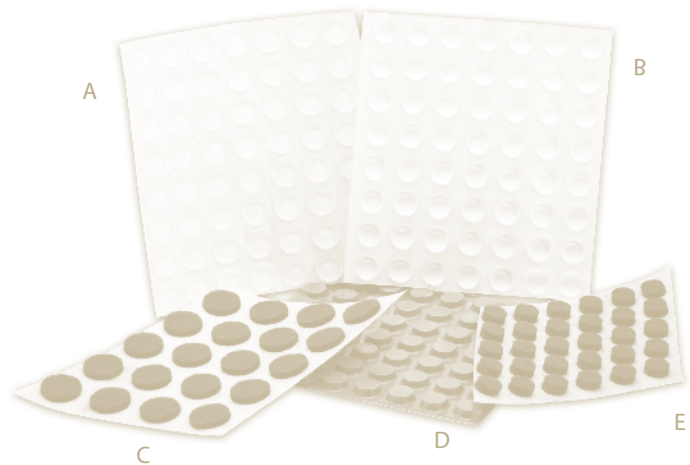

3M Bumpers and Felt Bumper Pads

Protect walls and keep pictures straight. Self-adhering, easily applied, rubber and brown felt pads. Resilient and non-marring.

- A** ITEM #25203 Clear Round Rubber Bumpers 1,000/box
- B** ITEM #25205 Clear Half-Round Rubber Bumpers 1,000/box
- C** ITEM #25213 5/8" Brown Felt Pads 1,000/roll
- D** ITEM #25201 Brown Rubber Bumpers 1,000/box
- E** ITEM #25211 3/8" Brown Felt Pads 1,000/roll

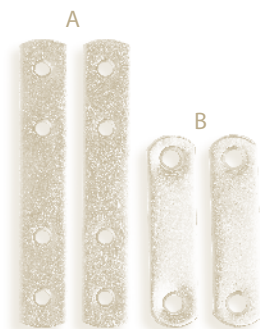

Mending Plates

These brass mending plates can be used to add additional support to cracked or split moulding. Screws provided.

- A** ITEM #24842 3" x 1/2" 100/bag
- B** ITEM #24840 2" x 1/2" 100/bag



Mighty Mounts

Clear plastic holders for shadow-box framing. Can be used to hold almost any size knife, plate, gun, spoon or coin and many other objects. Application tool included.

- A** ITEM #25804 Spoon/Object holder, 12/pkg.

B ITEM #25810 Multipurpose holder, 8 small, 8 large/pkg.

C ITEM #25802 Knife holder, 1/pkg.
- D** ITEM #25812 Gun holder, 1/pkg.

E ITEM #25806 Mint set; 2 holders each (U. S. coin size)

F ITEM #25808 Plate holder, 12/pkg.

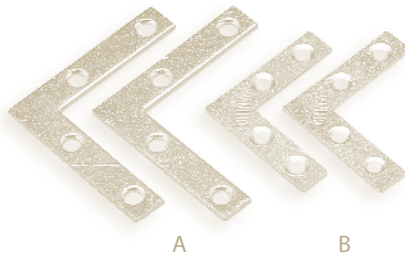

Corner Angles

These “L” shaped brackets can be used on the corners of large frames to add extra stability. Excellent for heavy frames as well. (Screws not provided, use with Item #24054.)

- A** ITEM #24832 2" 4/pkg.
- B** ITEM #24830 1 1/2" 4/pkg.

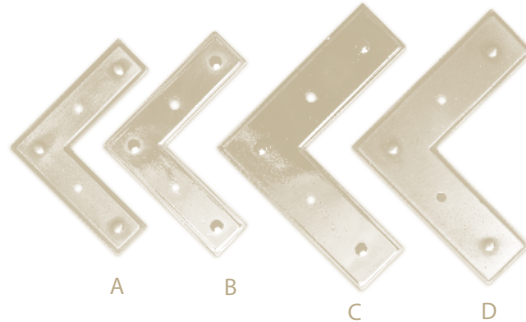

Thornhill Corner Ornaments

Industrial-styled corner ornaments in Polished Nickel and Brass offer the perfect finishing touch to the Jonathan Adler Thornhill Collection. With their simple 90° shape, they can work on many other frames, as well.

- A** ITEM #446B Brass Small 4/set
- B** ITEM #446N Nickel Small 4/set
- C** ITEM #541B Brass Large 4/set
- D** ITEM #541N Nickel Large 4/set

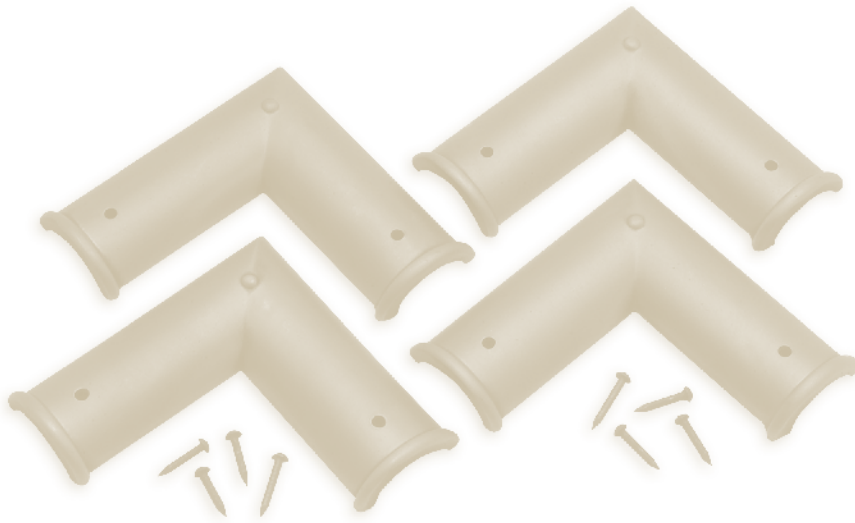

Decorative Corners for Wood Moulding

ITEM #900G Antique Gold Corner 4/Set
Corners are 1 1/4" wide and 3" long on the outside of each leg. Package contains 4 corners and nails. Fits moulding 565G.

ITEM #901G Antique Gold Corner 4/Set
Corners are 3/4" wide and 2 1/2" long on the outside of each leg. Package contains 4 corners and nails. Fits moulding 477G.



Stitchery Tape

Designed to adhere needle-art mounting surfaces. Double-sided tape with a mylar carrier and a clear adhesive. Will not turn acidic, but not recommended for conservation framing.

ITEM #26407 1 1/2" x 60 yds.

ITEM #21610 3/4" x 60 yds.



Z-Gel

Z-Gel gives posters, prints and pre-treated photographs the look of canvas while adding durability and protection against chemicals, water, and UV rays. Apply with a brush or roller to achieve desired texture.

ITEM #26409 Semigloss 1 gallon

ITEM #26411 Gloss 1 gallon

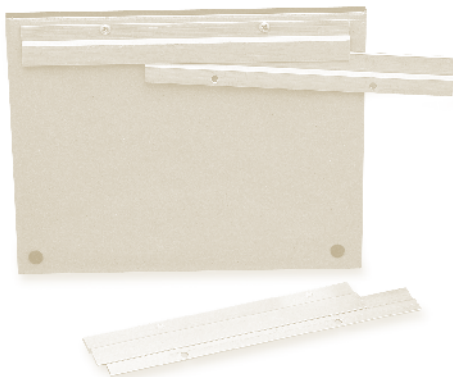

EZ-Bar

Innovative hanging system allows easy and safe hanging of heavy artwork. Hangs tightly to wall with 100% extruded aluminum and pre-drilled holes every 4" for easy stud positioning. Available in bundles of 24' (6' lengths) and two sizes. Screws not provided.

ITEM #26208 Regular (90 lbs. or less)

ITEM #26210 Super (90 lbs. or over)

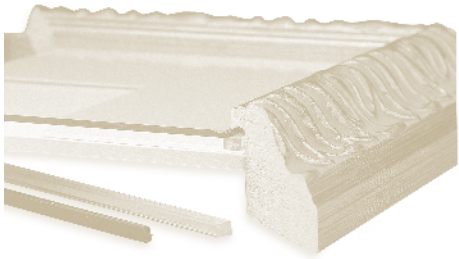

Arlo Spacemaker

Creates an air space between fine art and glazing to protect from mold, buckling and other contact damage. Narrower than other spacers at 3/16" wide. Hides under narrow wood or metal frame rabbets. 3M self-adhesive backing. Acid-free with no plasticizers. Available in clear, black and smoke.

ITEM #26025	1/8"	Clear	100'/tube
ITEM #26021	1/8"	Black	100'/tube
ITEM #26023	1/8"	Smoke	100'/tube
ITEM #26035	1/4"	Clear	50'/tube
ITEM #26031	1/4"	Black	50'/tube
ITEM #26033	1/4"	Smoke	50'/tube
ITEM #26070	1/16"	Econo Space Clear	100'/tube



FrameLight

Create custom LED lit shadowbox displays with Larson-Juhl mouldings. FrameLight is available fully assembled with your choice of Larson-Juhl moulding, or you can purchase the FrameLight display separately without moulding. The FrameLight displays include an on/off switch, which will automatically turn off after one hour. FrameLight requires two AA batteries and does not include glass or a backing board. When ordering an assembled FrameLight, please remember that the item number includes an "A" at the end of the number. Depth of the FrameLight boxes is 3 3/4".

ITEM #25711	14" x 14"
ITEM #25712	16" x 20"
ITEM #25713	22" x 28"
ITEM #25711A	14" x 14" Assembled
ITEM #25712A	16" x 20" Assembled
ITEM #25713A	22" x 28" Assembled



Jersey Pro

This pre-assembled 32" x 40" framing system includes a hanger to display your jersey, as well as Tru Vue Conservation Clear Glass and black foamboard backing. Flexipoints make it easy to remove the existing backing board and insert the matboard of your choice.

- ITEM #25700 Small Hanger, Black
- ITEM #25701 Large Hanger, Black
- ITEM #25702 Small Hanger, Mahogany
- ITEM #25703 Large Hanger, Mahogany



Guidelines for Great Frame Design

Greg Perkins provides insights into how to make the right design choices for custom framing and presents the concepts that guide those choices in down-to-earth terms.

ITEM #27897



Nielsen Sports Display Case

This pre-assembled 32" x 40" sports display case is built with a duotone metal frame, swiveling garment hanging system and UV Acrylic. The frame is front loading.

ITEM #25704

Kraft Paper and Dispenser

Heavy-duty brown or black paper on 36" or 48" rolls. Used for backing picture frames, wrapping, and protecting press surfaces. A must for every shop. Steel dispenser mounts directly onto your work table.

- ITEM #28802 36" Kraft Paper Dispenser
- ITEM #28815 24" Brown Kraft Paper
- ITEM #28812 36" Brown Kraft Paper
- ITEM #28813 36" Black Kraft Paper
- ITEM #28817 48" Brown Kraft Paper

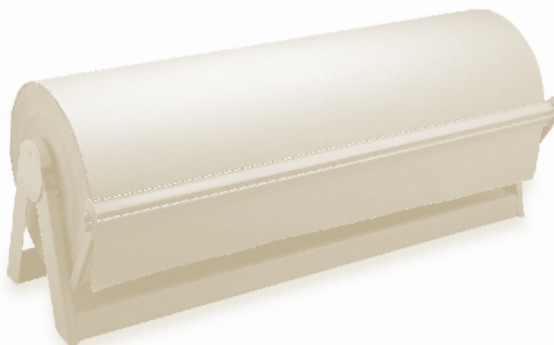

Protective Cardboard Corners

Protect your framed pieces from damage. Your customers will appreciate the tender loving care. 200-lb. test Oyster White cardboard.

- ITEM #29206 #3 Corners, 200/pack
Adjustable to fit 3 sizes: 1/2", 1" or 1 7/16"



Plastic Bags

.002-mil bags — great for a variety of uses, especially for wrapping completed frames.

- ITEM #29002 16 1/2" x 21" 575/roll
- ITEM #29006 24 1/2" x 36 1/2" 320/roll
- ITEM #29007 36" x 48" 325/roll
- ITEM #29008 44" x 66" 200/roll

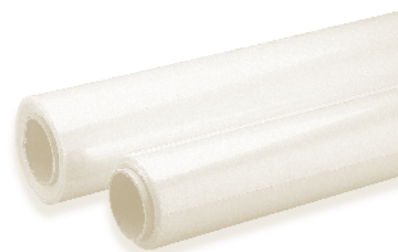

Shrink Film

Fine-quality center-folded shrink film for protecting graphic art. Will not sag or wrinkle after years of use. Available in 36" width and in gauges of 60 or 100.

- ITEM #14605 36" x 500' 60-gauge
- ITEM #14607 36" x 500' 100-gauge

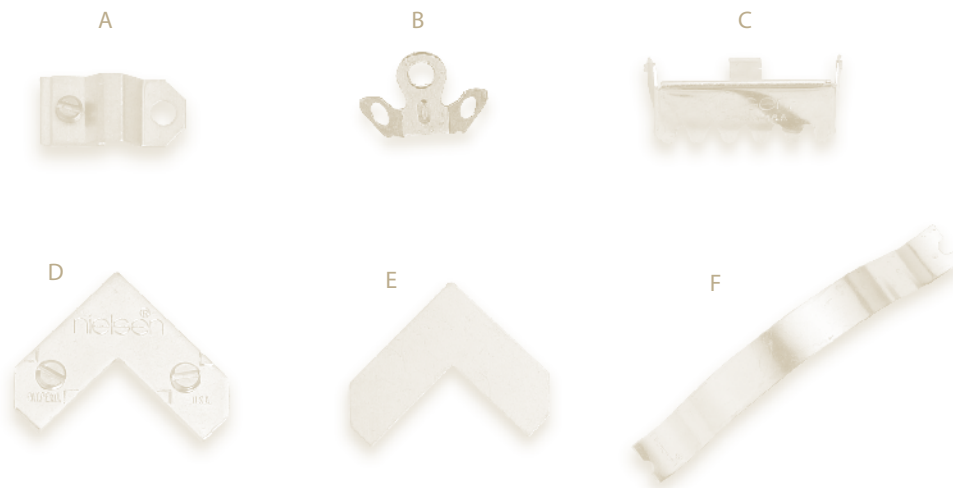

Nielsen Hardware

A Nielsen Omni Hanger

ITEM #H43 Individual polybag

B Nielsen Snap Hanger

ITEM #H104 Individual polybag

ITEM #H322 1,000/box

ITEM #H304 Bulk Set-100 frames

C Nielsen Notched Sawtooth Hangers

ITEM #H216 100/box

D Nielsen Tapped Angles

ITEM #H323 1,000/box

E Nielsen Bakeplates

ITEM #H324 1,000/box

F Nielsen Spring Clips

ITEM #H325 1,000/box



Nielsen Chevron Adhesive

Use on moulding corner samples for an easy display option.

ITEM #HA433 50/bag

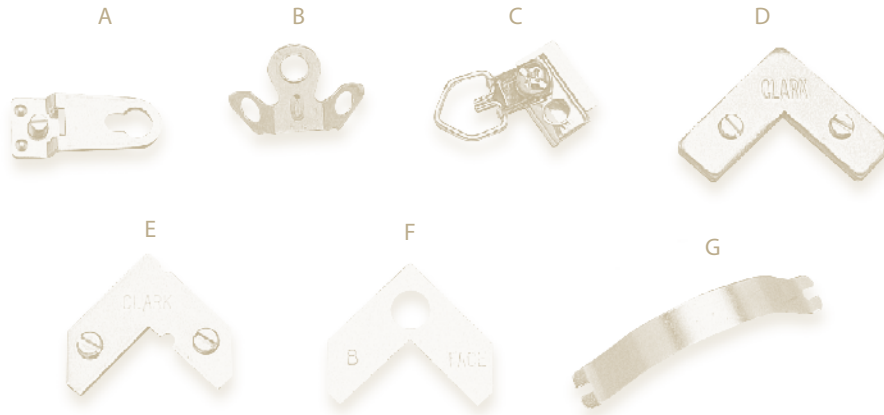

Metal Hardware

Polybag sets: Includes hangers, corner hardware, springs and bumpers to complete one picture (in one individually wrapped bag).

Bulk Sets: Includes hangers, corner hardware, springs and bumpers to complete 100 pictures (not individually wrapped).

Clark Hardware

A Clark Screw Hanger

- ITEM #H101 Individual polybag
- ITEM #H201 Bulk Set
- ITEM #H221 Screw Hangers only, 500/box

B Clark Snap Hanger

- ITEM #H102 Individual polybag

C Clark D-ring Hanger w/ Back Plate

Can be used with all metal frames except Nielsen 21. Profiles: Clark 1300; Nielsen 80

- ITEM #H105 Individual polybag
- ITEM #H215 D-ring Hanger only, 100/box

D Clark 3/16" Tapped Corner Plate

- ITEM #H107 Individual polybag
- ITEM #H227 Tapped Corner Plates only, 500/box

E Clark Tapped Angle

- ITEM #H101 Individual polybag
- ITEM #H223 Tapped Angles only, 1,000/box

F Clark Back Plates

- ITEM #H101 Individual polybag
- ITEM #H224 Back Plates only, 1,000/box

G Clark Spring Clips

- ITEM #H101 Individual polybag
- ITEM #H225 Spring Clips only, 1,000/box



Tru Vue Conservation Clear Glass

Protects artwork by absorbing 99% of harmful UV light, which can cause fading and other damage.

Item #	Lites/Case	Size
GCC1620	23	16" x 20"
GCC1824	17	18" x 24"
GCC2024	15	20" x 24"
GCC2228	12	22" x 28"
GCC2436	8	24" x 36"
GCC2632	9	26" x 32"
GCC3240	6	32" x 40"
GCC3648	4	36" x 48"
GC4060	2	40" x 60"
GCC4868	2	48" x 68"

Tru Vue Premium Clear Glass

High-quality USA-made clear glass is 2.5mm, washed and paper-interleaved.

Item #	Lites/Case	Size
G1114	47	11" x 14"
G1620	23	16" x 20"
G1824	17	18" x 24"
G2024	15	20" x 24"
G2228	12	22" x 28"
G2430	10	24" x 30"
G2436	8	24" x 36"
G2632	9	26" x 32"
G3240	6	32" x 40"
G3648	4	36" x 48"
G4060	3	40" x 60"

Tru Vue Conservation Reflection Control Glass

Protects artwork from damaging UV light while reducing glare and reflections. Absorbs 99% UV light.

Item #	Lites/Case	Size
GCRC2228	12	22" x 28"
GCRC2436	8	24" x 36"
GCRC3240	6	32" x 40"
GCRC3648	4	36" x 48"

Tru Vue UltraVue Glass

2mm water-white, anti-reflective glass. Absorbs 70% UV light.

Item #	Lites/Case	Size
GU3240	3	32" x 40"
GU3648	2	36" x 48"
GU4060	2	40" x 60"
GU4868	2	48" x 68"

Tru Vue AR Glass

This anti-reflective glass provides unlimited clarity and increased light transmission. Durable edge-to-edge coating reduces glare without loss in clarity.

Item #	Lites/Case	Size
GAR1620	3	16" x 20"
GAR2436	4	24" x 36"
GAR3240	3	32" x 40"
GAR3648	2	36" x 48"
GAR4060	2	40" x 60"

Tru Vue Museum Glass

Highest-quality picture framing glass available to the industry. Anti-reflecting technology coupled with 99% UV protection.

Item #	Lites/Case	Size
MG1620	4	16" x 20"
MGX1620	16	16" x 20"
MG1824	12	18" x 24"
MG2024	11	20" x 24"
MG2228	8	22" x 28"
MG2430	7	24" x 30"
MG2436	6	24" x 36"
GMS3240	1	32" x 40"
MG3240	4	32" x 40"
GMX3240	6	32" x 40"
MG3648	3	36" x 48"
GM4060	2	40" x 60"
MG4868	2	48" x 68"

Tru Vue Reflection Control Glass

Reflection factor is 8% for single-sided etched Reflection Control Glass. Reduces glare to less than 4%.

Item #	Lites/Case	Size
GR1114	47	11" x 14"
GR1620	23	16" x 20"
GR1824	17	18" x 24"
GR2024	15	20" x 24"
GR2228	12	22" x 28"
GR2430	10	24" x 30"
GR2436	8	24" x 36"
GR2632	9	26" x 32"
GR3240	6	32" x 40"
GR3648	4	36" x 48"
GR4060	2	40" x 60"



Acrylic

Tru Vue Optium Acrylic

- ITEM #51194 Optium Museum Acrylic, AR, 40" x 60", .118" thick
- ITEM #51198 Optium Museum Acrylic, AR, 48" x 96", .118" thick
- ITEM #51196 Optium Acrylic, AR, 48" x 96", .118" thick
- ITEM #51200 Optium Museum Acrylic, AR, 72" x 120", .236" thick
- ITEM #51245 Optium Museum Acrylic, AR, 72" x 96", .177" thick
- ITEM OPM2436 Optium Museum Acrylic, AR, 24" x 36", .118" thick (2 lites)
- ITEM OPM3240 Optium Museum Acrylic, AR, 32" x 40", .118" thick (2 lites)
- ITEM OPM3648 Optium Museum Acrylic, AR, 36" x 48", .118" thick

Acrylic Sheet Clear

Clear acrylic sheet has 87% UV protection.

- ITEM #50981 48" x 96", .098" thick
- ITEM #51181 48" x 96", .118" thick

Acrylite Sheet Non-glare

Non-glare acrylic sheet has 87% UV protection.

- ITEM #51183 48" x 96", .118" thick

Acrylite Sheet UV Filtering

Clear acrylic sheet with 98% UV filtering capabilities.

- ITEM #51185 48" x 96", .118" thick

Acrylite Non-glare UV Filtering

Non-glare acrylic sheet with 98% UV filtering capabilities.

- ITEM #51187 48" x 96", .118" thick

Boxed Acrylite

Premium Clear Acrylite

- ITEM #APC3240 3 lites, 32" x 40"
- ITEM #APC4060 2 lites, 40" x 60"

Reflection Control Acrylite

- ITEM #ARC3240 3 lites, 32" x 40"
- ITEM #ARC4060 2 lites, 40" x 60"

Conservation Clear Acrylite

- ITEM #ACC3240 3 lites, 32" x 40"
- ITEM #ACC4060 2 lites, 40" x 60"

Conservation Reflection Control Acrylite

- ITEM #ACRC3240 3 lites, 32" x 40"
- ITEM #ACRC4060 2 lites, 40" x 60"

2mm Acrylite

- ITEM #51188 1 lite, 48" x 96"

Static Shield

- ITEM #51190 48" x 96"



210 Plastic Polish

Useful tool for removing superficial acrylic scratches and polishing/cleaning acrylic sheeting.

- ITEM #28015 Cleaner and Polish



Beveled Mirror

Tru Vue beveled mirrors are 1/4" thick with a 1 1/4" bevel. Available in five sizes, individually packaged.

Item #	Size
BM1620	16" x 20"
BM2024	20" x 24"
BM2430	24" x 30"
BM2436	24" x 36"
BM3240	32" x 40"



Kaydry EX-L Low-Lint Wipers

Low-lint, scratch-free towel used to clean glass, plastic and general applications. This is not a paper towel. 90 15" x 17" wipers/box.

ITEM #28006



Larson-Juhl Super Wipes

These cotton/paper blended wipes leave no trace of dust. Excellent for glass or equipment cleanup. May be used over and over again.

ITEM #28008 Approximately 98
12" x 18" wipers



Glass Handling Gloves

Resistant to snags and abrasions, these glass handling gloves provide an excellent grip. They are ultra light-weight with a palm area coated with a thin layer of blended polyurethane to improve tactile sensitivity.

ITEM #28136 Small

ITEM #28138 Large



Larson-Juhl Glass Cleaner

Specially formulated for Larson-Juhl to provide the optically highest-quality cleaner available to the professional picture framer. Easy spray formulation dries streak-free, contains no ammonia and is ideal for all glass cleaning needs. 19.5 oz. can.

ITEM #28004



Sprayway Lint and Dust Remover

Compressed air removes dust and lint. 10 oz. can.

ITEM #28005



Sprayway Glass Cleaner

The industry standard for picture framers. Use with Kaydry towels or Super Blue Wipes for fast, thorough glass cleaning. Contains no ammonia. 15 oz. net weight.

ITEM #28002

Tru Vue Glass Cleaner

Safe for all glazing types. Ammonia-free and static-free.

ITEM #28001 26 oz.

- A**
 Acid-Free Tape 15, 18, 19
 Acrylic 40
 Acrylic Blades 13, 14
 Adhesives
 Corner Weld 15
 Fusion 4000 10
 Photo Mount 11
 Positionable Mounting 568 11
 Pure Rice Starch 19
 Spray Mount 11
 Super “77” Spray 11
 SureMount 11
 Techmount Tissues 10
 Vac-U-Mount 11
 “Yes” Paste 11
 Air
 Compressors 5
 Filter Regulator 6
 Hose 6
 Tools 6
 Albin Easel Mate 28
 Anchor Joining System 8
 Apron 23
 Arakawa Hanging System 26
 Arlo Spacemaker 34
 Artique Matboard Rack 14
 Artist’s Tape 17
 ATG Pick-Up Stick 17
 ATG Tape 16
 Attach-EZ Kit/Accessories 24
 Awl 22
- B**
 Backer Paper 20, 36
 Backing Paper/Dispenser 36
 Bags, Plastic 36
 Beveled Mirrors 40
 Black Kraft Paper 36
 Blades
 Acrylic 13, 14
 Blades, C&H 13, 14
 Blades, Carbide Glass 13
 Dexter #3 13, 23
 Fletcher 11, 13, 14
 Larson-Juhl 14
 Mat Cutter 13
 Notched 13
 Plastic 13, 14
 Single-Edge 14
 Steel Glass 13
 Utility 13
 Wizard CMC 14
 X-Acto 13, 23
 Zippy 9
 Blow Gun 6
 Books 35
 Box Sealing Tape 17
 Brad Gun 6
 Brads 21
 Brush, Anti-Static/Dusting 21
 BufferMount 9
 Bumper Pads 31
 Bumpons 31
 Burnishing Bone 20
- C**
 C&H
 Blades 14
 Thumbnail Inserts 8
 Caddy Picture Wire 26
 Canvas
 Clips 30
 Pliers 23
 Stapler/Staples 23
 Carbide Glass Wheels 13
 Cardboard Corners 36
 Cardboard, Glass, & Acrylic Cutter 12, 22
 Cassese
 Accessories 5, 6
 Flexipoints 7
 Joining Machines 4, 5
 Pneumatic Guns 7
 V-nails 7, 8
 Wedges 7
 Chopper (Fillet) 8
 Circular Extension Table 6
 Clark Metal Hardware 38
 Cleaners
 Glass 40, 41
 Plastic 41
 Platen Kit 8
 Clips
 Canvas Clips 30
 Offset Clips 30
 Coil Hose 6
 ColorMount 10
 Compressors & Accessories 5, 6
 Conservation Glass 39
 Conservation Supplies 15-20
 Corner Angles 32
 Corner Ornaments 32, 33
 Corner Weld Wood Glue 15
 Cotton Gloves 19
 Cutters
 Cardboard, Glass & Acrylic 12, 22
 Mat Cutter 12
 Multi Materials 12
- D**
 D&K
 Mounting Presses 9
 Accessories 9
 Platen Cleaning Kit 8
 Decorative Corners 32, 33
 Dexter #3 Blades 13, 23
 Dispensers
 ATG 15
 Kraft Paper 36
 Display Case 35
 Document Cleaning Pad 20
 Double-Screw Strap Hangers 28
 Double-Sided Tape 16
 Drivers, Cassese 7
 Dry-Mount Presses 9
 Dry-Mount Tissues/Accessories 10
 Dusting Brush 21
- E**
 Easel Backs 31
 Easel Mates 28
- E**
 Eraser-Kneaded 14
 EZ-Bar 33
 EZ-Tach/Accessories 24
- F**
 Felt Bumper Pads 31
 Filament Tape 17
 Fillet Choppers & Blades 8
 Fillet Tape 16
 Filmoplast Tape 18
 Filtration System 6
 Finish Guard 10
 Fletcher
 Attach-EZ 24
 Blades 11, 12, 13, 14
 Carbide Glass Cutter 22
 Cardboard, Glass & Plastic 12
 FlexiMaster Driver 21
 Handtools 22, 23
 Mat cutters 12
 Multi-Material Cutter/Blades 12
 Point Drivers 21
 Points 21, 22
 T-End Fasteners 24
 Wheels 11, 12, 13
 Flocked Door Easel Back 31
 Foamboard Hangers 28
 FrameLight 34
 Frame Sealing Tape 19
 Framebacker Paper 20, 36
 Framers’ Apron 23
 Framers’ Tape 19
 Fusion 4000 10
- G**
 Glass
 Anti-reflective 39
 Carbide Wheel 11, 12, 13
 Conservation 39
 Cleaner 40, 41
 Cutters, Hand 22
 Handling Gloves 41
 Museum 39
 Plexi-Glass 40
 Pliers/Nippers 22
 Premium Clear 39
 Steel Wheel 11, 12, 13
 Tru Vue 39, 40
 Gloves 19, 41
 Glue
 Corner Weld 15
 Wood 15
 “Yes” Paste 11
 Gripster Knife 23
 Guidelines for Great Frame Design 35
- H**
 Hand Tools 22
 Hangers
 Courtesy 27
 Foamboard 28
 Metal Security 29
 Nail-Less Sawtooth 27
 Sawtooth 27
 Screw Eye 27
 Single-Hole Strap 28
 Strap 28
 “Super Steel” 28
 WallBuddies 29
 Wood Security 29
 Zig-Zag 28
 Hanging System 26, 33
 Heat Presses 9
 Highland ATG Tape 16
 Hinging Paste 19
 Hinging Tape 18, 19
 Hook & Loop Tape 17, 18
- J**
 Jersey Pro 35
 Joining Machines
 Cassese 4, 5
 Joining Vise 21
 Jun-Air Compressor 5
- K**
 KayDry Wipes 41
 Kneaded Eraser 14
 Kraft Paper/Dispenser 36
 Kwik Foamboard Hangers 28
- L**
 Larson-Juhl
 Anchor Joining System 8
 ATG 16
 Backing Paper 20
 Blades 14
 Bumpers 31
 Coalescent Filer Intake Filter 5
 Compressors 5
 Conservation Corner Mounts 20
 Filters 5
 Framers’ Apron 23
 Glass Cleaner 41
 Picture Hangers 27
 Picture Wire 26
 Print Weights 23
 Super Wipes 41
 Vise 21
 Lineco
 Abaca Tape 18
 Frame Sealing Tape 19
 Framebacker Paper 20
 Mounting Strips 19
 Rabbit Foam Tape 19
 Rice Starch Adhesive 19
 Self Adhesive Linen Tape 18
- M**
 Magic Tape 17
 Markers 25
 Masking Tape 16
 Mat
 Blades 13, 14
 Cardboard/Glass Cutter 13
 Cutters 12
 Sample Rack 14
 Mending Plates 31
 Metal
 Hardware 37, 38
 Security Hangers 29
 Microtach Fasteners 24

Mighty Mounts	32	S	Thumbnail Joiners/Bits	8	
Mirror Strap Hangers	28	Safety Blow Gun	6	Touch-Up Markers	25
Mirrors, Beveled	40	Sanding Disk	8	Tru Vue	40
Mitre Tru Sanding Disk	8	Sawtooth Hangers/Nail-Less	27	Turnbuttons	30
Mounting		Scoring Tools	22	U	
Corners	20	Scotch Dispenser Gun	15	Uni-Frames	30
Mighty Mounts	32	Scratch Remover	41	Universal "AL" Wedges	8
Mylar Strips	19	Screw Eyes	27	Universal Wedges	8
Object Holders	32	Screws	27	Utility Blades	13, 14, 23
Presses	9	Sealing Tape	17	Utility Knife	23
Tissues/Accessories	9, 10	Security Hangers		V	
Mulberry Paper Strips	19	Metal	29	V-Nails	7, 8
Multi Materials Cutter	12	Wood	29	Vac-U-Mount Adhesive	11
N		Shrink Film	36	VacuPress	9
Nail-Less Sawtooth Hangers	27	Single-Edge Blades	14	Velcro	
Nail Hole Fillers	25	Single-Screw Strap Hangers	28	Hook & Loop Tape	17
Nielsen Hardware	37	Spacers	34	Nielsen Chevron	37
Nielson Sports Display Case	35	Sponge Foam Overlay	10	Triangles	17
Notched Blades	13	Spray Adhesives		Vise	21
O		Photo Mount	11	W	
Offset Clips	30	Spray Mount	11	WallBuddies Hangers	29
Oil for Jun-Air	5	Super "77"	11	Wall Cutters	12
Oil & Water Filtration System	6	Vac-U-Mount	11	Wedge	
P		Sprayway Glass Cleaner	41	Drivers	7
Paper Paste	19	Sprayway Lint and Dust Remover	41	V-Nails	7, 8
Paper Strips	19	Staplers, Canvas	23	Wipes	41
Paste, "Yes"	11	Staples		Wire	26
Photo Mount	11	Canvas	23	Wire Caddy	26
Pick Up Stick	17	For SJS Stapler	7	Wiring System	26
Picture Wire	26	Static Wisk Framer's Brush	21	Wood Glue	15
Picture Caddy	26	Steel Glass Wheels	11, 12, 13	Wood Security Hangers	29
Pinners	4, 5	Stitchery Tape	33	Wrench for Security Hangers	29
Plastic		Strap Hangers	28	X	
Bags	36	Stretching Pliers, Canvas	23	X-Acto Blades	13, 23
Blades	13, 22	Super "77" Spray Adhesive	11	X-Acto Gripster Knife/Blades	23
Cleaner	41	Super Soft Strand Wire	26	Y	
Polish (210)	40	Super Wipes	41	"Yes" Paste	11
Plastic Coated Wire	26	"Super Steel" Hangers	28	Z	
Platen Cleaner Kit	8	SureMount Vacuum Adhesive	11	Z-Gel	33
Plexi-Glass	40	Surflon Wiring System	26	Zippy Cutter Blades	9
Pliers		T			
Canvas	23	3M			
Glass	22	Artist's	17		
PMA	11	ATG	15, 16		
Pneumatic Handtools/Accessories	6	Bumper pads/Bumpons	31		
Point Drivers	21	Box Sealing Tape	17		
Positionable Mounting 568	11	Conservation Tape, 889	15		
Presses	9	Filament	17		
Print		Masking	16		
Sleeves	20	Mounting Adhesive	11		
Weights	23	Performance Cloths	41		
Professional Mat Cutter System	12	Photo Mount Adhesive	11		
Protective Cardboard Corners	36	Positionable Mounting 568	11		
Putnam V-Nails	7	Scotch Dispenser Gun	15		
R		Spray Adhesives	11		
Rabbit Foam Tape	19	Spray Mount Adhesive	11		
Rack, Artique Matboard	14	Super "77" Adhesive	11		
Ragmount	10	Tapes	15-19		
Release Boards/Papers	10	Transparent	17		
Rice Starch	19	Transfer Tape	15, 16		
Rub 'n Buff	25	Vac-U-Mount Adhesive	11		
		Tape Measure	23		
		Tapes	15-19, 33		
		Techmount Mounting Tissue	10		
		Thornhill Corner Ornaments	32		

LARSON · JUHL

TO ORDER EQUIPMENT & SUPPLIES CALL 800-438-5031
OR ORDER ONLINE WITH LJCONNECT AT WWW.LARSONJUHL.COM